

TM 11-5820-358-10

DEPARTMENT OF THE ARMY TECHNICAL MANUAL

OPERATOR'S MANUAL,

RADIO RECEIVER R-390A/URR



*HEADQUARTERS, DEPARTMENT OF THE ARMY
16 JANUARY 1961*

WARNING

DANGEROUS VOLTAGES EXIST IN THIS EQUIPMENT

Be careful when working on the 240-volt power supply and the circuits connected to it, or on the 115/230-volt ac line connections. Before connecting the receiver to an ac source, be sure that the chassis is connected to the same ground as the ac source.

DON'T TAKE CHANCES!

CHANGED TO
C-2
JAN 15/65.

*TM 11-5820-358-10

TECHNICAL MANUAL }
No. 11-5820-358-10 }

HEADQUARTERS,
DEPARTMENT OF THE ARMY
WASHINGTON 25, D. C., 16 January 1961

RADIO RECEIVER R-390A/URR

			Paragraph	Page
CHAPTER	1.	INTRODUCTION		
	Section I.	General		
		Scope	1	3
		Forms and records	2	3
	II.	Description and data		
		Purpose and use	3	3
		System application	4	3
		Technical characteristics	5	5
		Components of Radio Receiver R-390A/URR	6	5
		Description	7	5
		Additional equipment required	8	6
CHAPTER	2.	OPERATING INSTRUCTIONS		
	Section I.	Controls and instruments		
		General	9	8
		Receiver controls and indicators	10	8
	II.	Operation		
		Preparing receiver for reception	11	9
		Calibration	12	9
		Tuning receiver for voice reception	13	9
		Mcw or cw reception	14	9
		Reception of frequency-shift signals	15	9
		Single-sideband reception	16	9
		Stopping procedure	17	24
		Antijamming instructions	18	24
CHAPTER	3.	MAINTENANCE INSTRUCTIONS		
		Scope of operator's maintenance	19	26
		Preventive maintenance	20	26
		Checking fuses	21	26
		Visual inspection	22	26
		Operational checklist	23	26
CHAPTER	4.	SHIPMENT AND LIMITED STORAGE AND DEMOLITION TO PREVENT ENEMY USE		
	Section I.	Shipment and limited storage		
		Disassembly	24	30
		Repacking for shipment or limited storage	25	30
	II.	Demolition of materiel to prevent enemy use		
		Authority for demolition	26	30
		Methods of destruction	27	30
APPENDIX	I.	REFERENCES		31
	II.	BASIC ISSUE ITEMS LIST, RADIO RECEIVER R-390A/URR		32

*This manual supersedes so much of TM 11-856A, 20 January 1956, including C1, 19 March 1956; C2, 17 May 1956; C3, 23 November 1956; C4, 7 June 1957; C5, 23 July 1958, and C6, 13 November 1958, as pertains to the operation of the equipment.

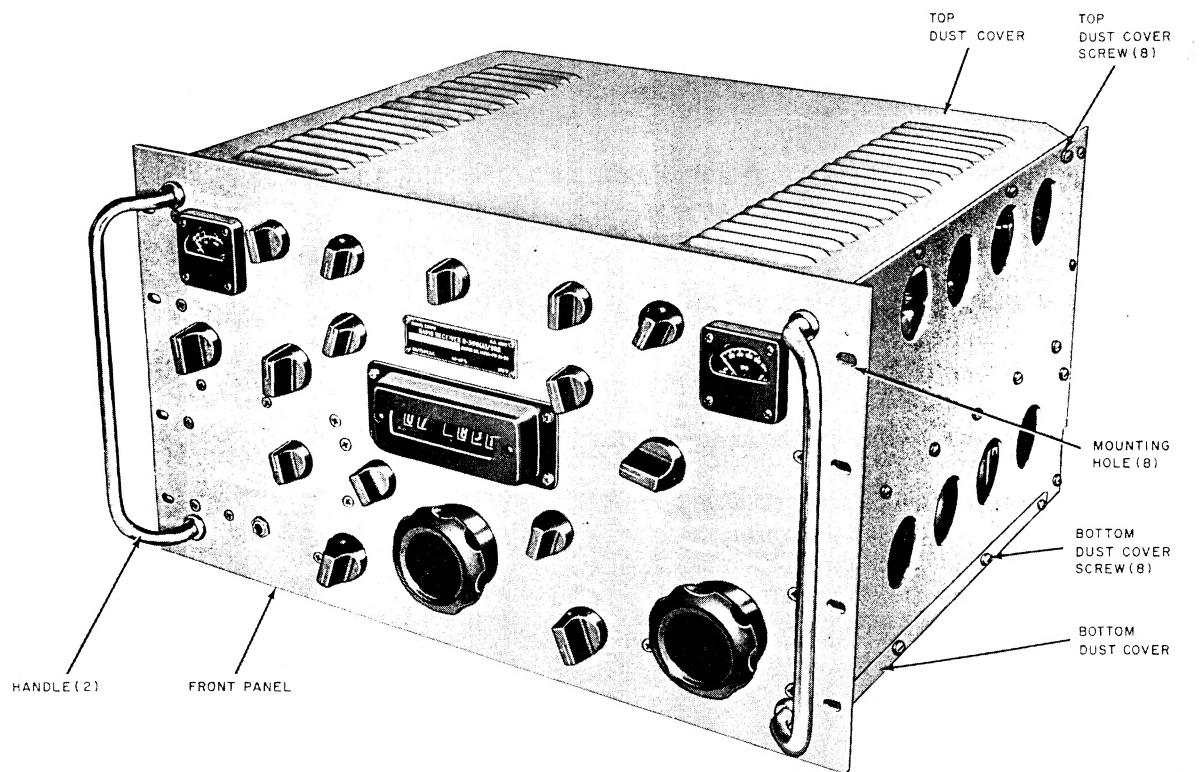

TM 5820-358-10-1

Figure 1. Radio Receiver R-390A/URR.

CHAPTER 1

INTRODUCTION

Section I. GENERAL

1. Scope

This manual describes Radio Receiver R-390A/URR (fig. 1) and covers its operation, and operator's maintenance. It includes cleaning and inspection of the equipment and replacement of parts available to first echelon maintenance. Throughout this manual, Radio Receiver R-390A/URR is referred to as the receiver.

2. Forms and Records

a. Unsatisfactory Equipment Reports.

- (1) Fill out and forward DA Form 468 (Unsatisfactory Equipment Report) to the Commanding Officer, U. S. Army Signal Materiel Support Agency, ATTN: SIGMS-ML, Fort Monmouth, N. J., as prescribed in AR 700-38.
- (2) Fill out and forward AF TO Form 29 (Unsatisfactory Report) to the Commander, Air Materiel Command, Wright-Patterson Air Force Base, Ohio, as prescribed in AF TO 00-35D-54.

b. Report of Damaged or Improper Shipment. Fill out and forward DD Form 6 (Report of Damaged or Improper Shipment) as prescribed in AR 700-58 (Army), Navy Shipping Guide, Article 1850-4 (Navy), and AFR 71-4 (Air Force).

c. Preventive Maintenance Form. Prepare DA Form 11-238 (fig. 15), (Maintenance Check List for Signal Equipment (Sound Equipment, Radio, Direction Finding, Radar, Carrier, Radiosonde, and Television)) in accordance with instructions on the form.

d. Parts List Form. Forward DA FORM 2028, (Recommended Changes to DA Technical Parts Lists or Supply Manuals 7, 8, or 9) directly to the Commanding Officer, U. S. Army Signal Materiel Support Agency, ATTN: SIGMS-ML, Fort Monmouth, N. J., with comments on parts listings in Appendix II.

e. Comments on Manual. Forward all other comments on this publication directly to the Commanding Officer, U. S. Army Signal Materiel Support Agency, ATTN: SIGMS-PA2d, Fort Monmouth, N. J.

Section II. DESCRIPTION AND DATA

3. Purpose and Use

a. The receiver (fig. 1) is a general-purpose receiver for use in both fixed and mobile applications. The receiver provides reception of continuous-wave (cw), modulated-continuous-wave (mcw), amplitude-modulated (am.), frequency-shift keyed (fsk), and single-sideband (ssb) signals.

b. The receiver furnishes audiofrequency (af) output power to a local loudspeaker and headset or a balanced line. An intermediate frequency (if.) output is also provided so that received radio teletypewriter signals may be fed to other equipment for conversion into signals usable by teletypewriter printers.

c. The calibration of the receiver is ac-

curate to within 300 cps; this permits use of the receiver as a frequency meter.

4. System Application

a. Space-Diversity Receiving System.

- (1) Two or three receivers can be connected as a space-diversity receiving system for reception of voice signals (fig. 2). This system provides substantially uniform audio output to a loudspeaker or headset, minimizing the effect of fading signals.

- (2) Rhombic or doublet antennas spaced at least 600 feet apart are connected to the two receivers.

b. Space-Diversity Radio Teletypewriter

System. Figure 3 shows two receivers connected in a space-diversity radio teletypewriter system. The doublet or rhombic antennas feed the incoming frequency-shift signals to the receivers. The outputs of the receivers are applied to a converter which provides diversity combining and produces direct current (dc) signals for the operation of teletypewriter equipment.

c. Single-Sideband Radio Teletypewriter System. A receiver and a single sideband converter may be connected as shown in figure 4.

This system permits the reception of single-sideband (ssb) signals, occupying 12 kc of rf spectrum space divided into two 6-kc sidebands, one 6-kc sideband on each side of a reduced carrier. A double-sideband signal, either am. or phase-modulated (pm), occupying up to a total of 12 kc of spectrum space also can be received. This system is used primarily for the reception of multichannel radio-teletypewriter transmissions. For additional information, refer to TM 11-649.

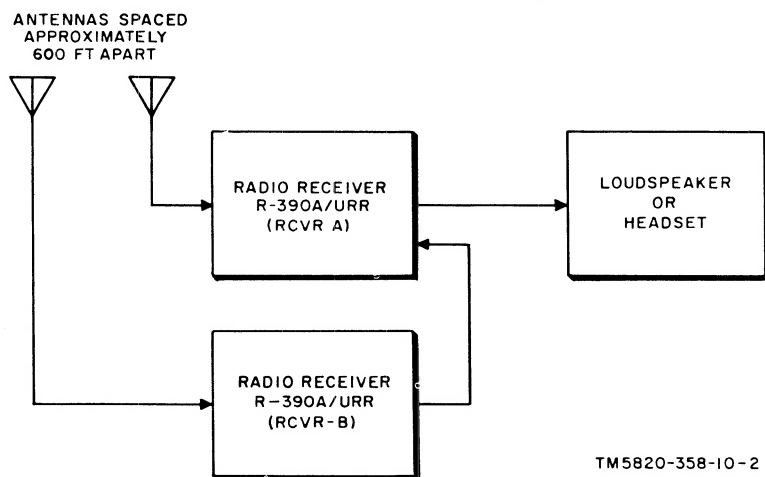

Figure 2. Space-diversity receiving system, block diagram.

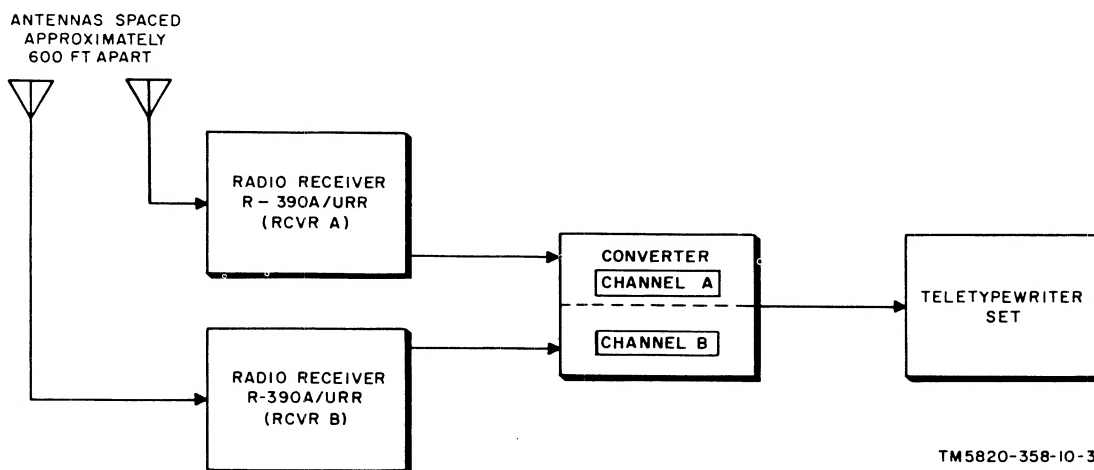

Figure 3. Space-diversity radio teletypewriter receiving system, block diagram.

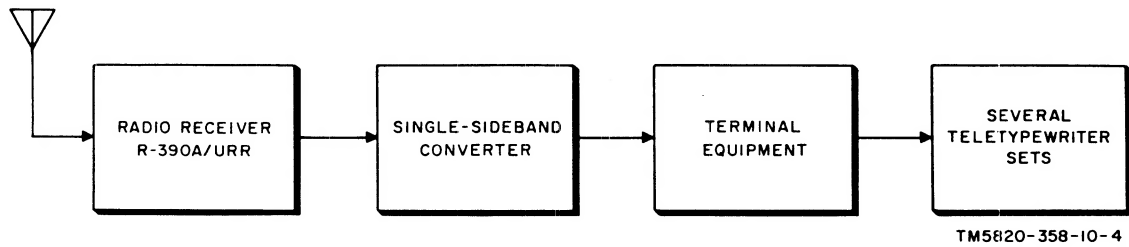

Figure 4. Single-sideband radio teletypewriter receiving system, block diagram.

5. Technical Characteristics

Frequency range 0.5 to 32 mc.
 Type of signals Cw, mcw, voice, ssb, fsk.
 received
 Type of tuning Continuous; frequency
 read directly on coun-
 tertype indicator.
 Method of Built-in crystal-controlled.
 calibration
 Calibration points .. Every 100 kc.
 Power source 115 or 230 volts ac $\pm 10\%$,
 48 to 62 cps.
 Power input 250 watts total; 140 watts
 with OVENS switch
 turned to OFF.

Antenna

requirements:

Unbalanced Straight wire of random
 length or vehicular-
 mounted whip.

Balanced 125-ohm terminating im-
 pedance; matches 50- to
 200-ohm balanced or
 unbalanced transmis-
 sion line by use of adap-
 ters.

6. Components of Radio Receiver R-390A/URR

a. *Components.* The components of Radio Receiver R-390A/URR are listed in the following table:

Quantity	Item	Fig. No.	Height (in.)	Depth (in.)	Width (in.)	Unit weight (lb)
1	Radio Receiver R-390A/URR	1	10 15/32	16 19/32	19	75
2	TM 11-5820-358-10					
1 set	Running spares (b below)	5				1

b. *Running Spares.* (fig. 5). The following is a list of running spares except as noted.

Quantity	Item
1	Electron tube, OA2
1	Electron tube, 6AK6
1	Electron tube, 6C4
1	Electron tube, 6DC6
1	Electron tube, 26Z5W
1	Electron tube, 5654/6AK5W
2	Electron tube, 5749/6BA6W
2	Electron tube, 5814A
5	Fuses, 3-ampere, 250-volt
1	Lamp, incandescent, 6-volt, 0.2-ampere, Federal Spec. No. W-L-11
1	Resistor, current-regulating
5	^a Fuses, 1/4-ampere, 250-volt
5	^a Fuses, 1/8-ampere, 250-volt

^a Only on receivers bearing Order No. 15-PHILA-56, serial numbers 2683 and above, and Order No. 14385-PHILA-58.

7. Description

a. The receiver (fig. 1 and 6) is designed for mounting in a standard 19-inch rack or a table-top cabinet.

b. All operating controls, indicators, and a PHONES jack are located on the front panel. Two handles are provided to aid in removal of the receiver from the rack or cabinet. The chassis is enclosed by dust covers which may be removed when the receiver is installed in a cabinet.

c. Antenna connectors, operating and spare fuses, a power cord, an if. connector, an OVENS switch, terminal boards, and special tools are mounted on the rear panel (fig. 7).

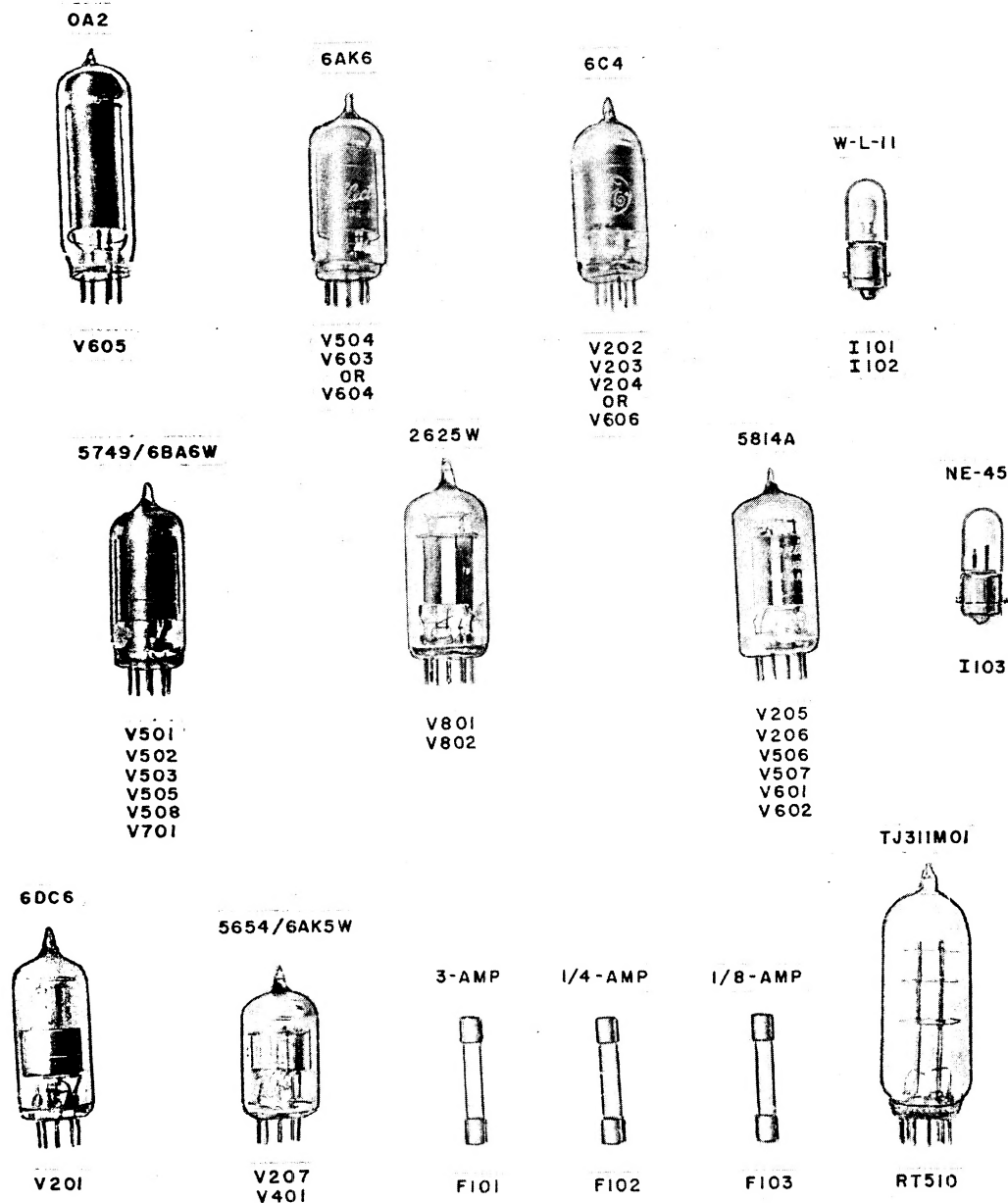

TM5820-358-10-5

Figure 5. Running spares.

Cutouts are provided to permit access to internal controls.

8. Additional Equipment Required

The following material is *not* supplied as a part of Radio Receiver R-390A/URR but is required for its operation. The connectors required will depend on the particular installation.

Antenna:

- Balanced Doublet or rhombic.
- Unbalanced Random-length straight-wire or whip.

Low-impedance transmission line:

- Balanced 50 to 200 ohms.
- Unbalanced 70-ohm coaxial cable.

Connector	Connector Plug UG-573/U or Connector Plug PL-259.		917/URR (Mobile) CY-1216/U or CY-979/URR
Headset	Headset Navy type CW-49507 or equivalent 600-ohm headset.	Adapter Connector UG-970/U	Adapts Connector Plug PL-259 on unbalanced antenna lead-in to balanced antenna input.
Cord	Headset Cord CX-1334/U, or equivalent.		
Loudspeaker	LS-166/U, or equivalent.	Adapter Connector UG-971/U	Adapts Connector Plug UG-573/U on unbalanced antenna lead-in to balanced antenna input.
Mounting and housing facilities	Standard 19-inch rack or cabinet such as: (Fixed) CY-1119/U or CY-		

CHANGE C 2

4. TO PREVENT DAMAGE TO THE RCVR, BE SURE TO TURN THE DIAL LOCK CONTROL COUNTERCLOCKWISE UNTIL IT STOPS BEFORE TURNING THE KILOCYCLE CHANGE CONTROL. DO NOT FORCE THE DIAL LOCK CONTROL BEYOND THE NORMAL STOP POSITION IN EITHER DIRECTION.

5. WHEN TURNING THE ZERO ADJ CONTROL KNOB, BE CAREFUL NOT TO FORCE THE KNOB COUNTERCLOCKWISE BEYOND THE STOP. THE SHAFT CAN BE TURNED TO A POINT AT WHICH THE PLATE ON THE END OF THE SHAFT IS FORCED OFF.

Change C2
see Pg 7

CHAPTER 2 OPERATING INSTRUCTIONS

Section I. CONTROLS AND INSTRUMENTS

9. General

Haphazard operation or improper setting of the controls can result in poor reception; therefore, it is important to know the function of every control. The actual operation of the equipment is given in paragraphs 11 through 18.

Cautions:

1. Do not turn the MEGACYCLE CHANGE

control beyond 00 or 31 megacycles.

2. Do not turn the KILOCYCLE CHANGE control beyond 000 counterclockwise or 999 clockwise. If a + or - appears in the third frequency indicator column from the left, the control has been turned too far.

3. Do not turn the FUNCTION switch counterclockwise beyond OFF or clockwise beyond CAL.

10. Receiver Controls and Indicators (fig. 6)

4. See Pg 7

Control or indicator	Function															
LINE LEVEL meter	Indicates level of balanced-line audio output.															
LINE METER switch	Meter switch has four positions:															
	<table style="width: 100%; border: none;"> <tr> <td style="text-align: left; width: 15%;"><i>Sw Pos</i></td> <td style="text-align: right; width: 15%;"><i>Effect</i></td> <td></td> </tr> <tr> <td>OFF</td> <td></td> <td>Disconnects meter from balanced-line audio output.</td> </tr> <tr> <td>+10</td> <td></td> <td>Adds 10 vu to LINE LEVEL meter vu indication.</td> </tr> <tr> <td>0</td> <td></td> <td>Reads LINE LEVEL meter directly.</td> </tr> <tr> <td>-10</td> <td></td> <td>Subtracts 10 vu from LINE LEVEL meter indication.</td> </tr> </table>	<i>Sw Pos</i>	<i>Effect</i>		OFF		Disconnects meter from balanced-line audio output.	+10		Adds 10 vu to LINE LEVEL meter vu indication.	0		Reads LINE LEVEL meter directly.	-10		Subtracts 10 vu from LINE LEVEL meter indication.
<i>Sw Pos</i>	<i>Effect</i>															
OFF		Disconnects meter from balanced-line audio output.														
+10		Adds 10 vu to LINE LEVEL meter vu indication.														
0		Reads LINE LEVEL meter directly.														
-10		Subtracts 10 vu from LINE LEVEL meter indication.														
LINE GAIN control	Controls level of signal applied to balanced-line audio output terminals.															
AGC switch	Determines rapidity of change in gain of receiver for a change of signal strength.															
LIMITER switch and control	Increasing clockwise rotation of control increases reduction of static interference.															
CARRIER LEVEL meter	Indication of 0 db with RF GAIN control at 10 corresponds to an input signal of approximately 2 microvolts.															
BANDWIDTH switch	Causes the receiver to reject frequencies that differ from the carrier frequency by more than the amount adjusted for.															
BFO switch	Makes cw signals audible.															
BFO PITCH control	Varies tone when receiving cw signals.															
AUDIO RESPONSE switch	<table style="width: 100%; border: none;"> <tr> <td style="text-align: left; width: 15%;"><i>Sw Pos</i></td> <td style="text-align: right; width: 15%;"><i>Effect</i></td> <td></td> </tr> <tr> <td>Sharp</td> <td></td> <td>800 cps tone is loudest; used for cw.</td> </tr> <tr> <td>Wide</td> <td></td> <td>Most voice frequencies are heard.</td> </tr> </table>	<i>Sw Pos</i>	<i>Effect</i>		Sharp		800 cps tone is loudest; used for cw.	Wide		Most voice frequencies are heard.						
<i>Sw Pos</i>	<i>Effect</i>															
Sharp		800 cps tone is loudest; used for cw.														
Wide		Most voice frequencies are heard.														
BREAK IN switch	Permits break-in operation with proper connections have been made at rear panel.															
FUNCTION switch	Function switch has five positions.															
	<table style="width: 100%; border: none;"> <tr> <td style="text-align: left; width: 15%;"><i>Sw Pos</i></td> <td style="text-align: right; width: 15%;"><i>Effect</i></td> <td></td> </tr> <tr> <td>OFF</td> <td></td> <td>Receiver is turned completely off.</td> </tr> <tr> <td>STAND BY</td> <td></td> <td>Receiver inoperative, but ready for instant use.</td> </tr> </table>	<i>Sw Pos</i>	<i>Effect</i>		OFF		Receiver is turned completely off.	STAND BY		Receiver inoperative, but ready for instant use.						
<i>Sw Pos</i>	<i>Effect</i>															
OFF		Receiver is turned completely off.														
STAND BY		Receiver inoperative, but ready for instant use.														

Control or indicator	Function
	AGC Receiver operative, with gain controlled automatically.
	MGC Receiver operative, with gain controlled by RF GAIN control or by an external control.
	<i>Sw Pos</i> <i>Effect</i> Cal Permits calibration of the tuning system at 100-kc checkpoints.
ANT TRIM control	Permits peaking of received signal to maximum value.
DIAL LOCK	When turned clockwise, locks KILOCYCLE CHANGE control to prevent accidental change of setting.
ZERO ADJ	When turned clockwise, disengages frequency indicator from KILOCYCLE CHANGE control for calibration purposes.
LOCAL GAIN control	Controls level of af signal applied to local headset or loudspeaker.
RF GAIN control	Manual control of amplification of received signal.
MEGACYCLE CHANGE control	Selects any one of 32 tuning bands in steps of 1 megacycle; changes reading of first two digits of frequency indicator.
KILOCYCLE CHANGE control	Tunes receiver to any frequency within a 1-megacycle band; changes reading of last three digits of frequency indicator.
PHONES jack	Provides means of connecting headset to receiver.

Section II. OPERATION

11. Preparing Receiver for Reception

A sample frequency of 07.275 megacycles will be used in paragraphs 11 through 15; it is understood that the operator will substitute the desired frequency. For preparatory procedure, refer to figure 8.

12. Calibration

The receiver is now ready for calibration. To maintain maximum tuning accuracy, calibrate the frequency indicator at the 100-kc point nearest the desired frequency. Recalibrate whenever the MEGACYCLE CHANGE control is turned. Start with the controls set as in paragraph 11. For calibration procedure, refer to figure 9.

13. Tuning Receiver for Voice Reception

Start with controls set as in paragraph 11. For voice reception tuning procedure, refer to figure 10.

14. Mcw or Cw Reception

Set up the controls the same as for voice reception (para 13). For mcw or cw reception, refer to figure 11.

15. Reception of Frequency-Shift Signals

The following procedure can be used for tuning the receiver to frequency-shift signals, unless another procedure is given in the technical manual covering the particular receiving system. The receiver requires exact tuning for this type of operation. The entire procedure applies only to systems that use the audio output of the receiver, such as Radioteletype Terminal Equipment AN/FGC-1. Omit the procedure given in step 4, figure 12, with equipments that use the if. output of the receiver, such as Frequency Shift Converter CV-116/URR. Set up the receiver the same as for mcw or cw reception (para 14). For reception of frequency-shift signals, refer to figure 12.

16. Single-sideband Reception

Tuning the receiver for ssb reception must be done accurately if this type of signal is to be received. Calibrate the receiver as shown in paragraph 12. Start with the receiver set up as in paragraph 14. For ssb tuning procedure refer to figure 13.

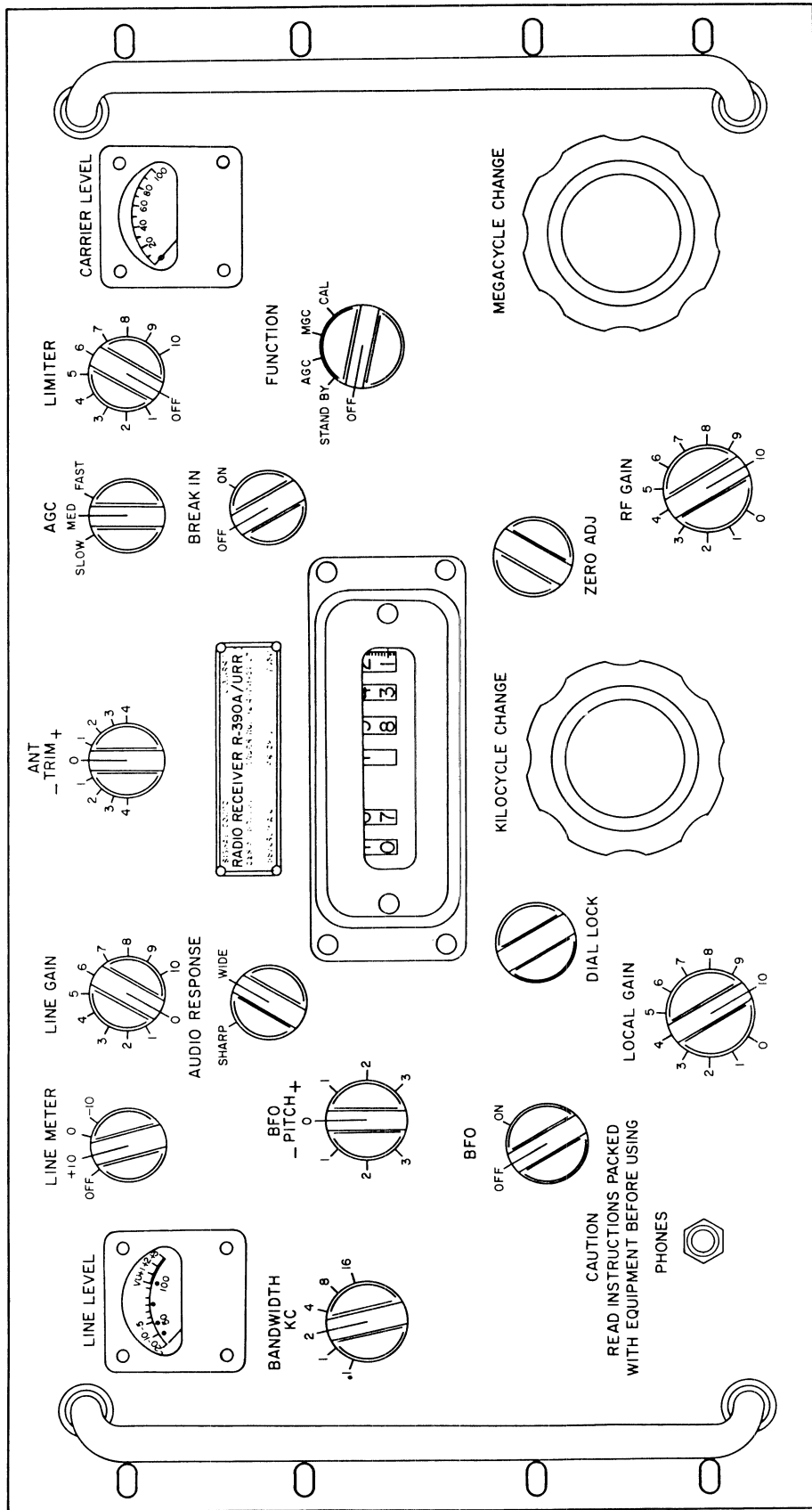

TM5820-358-10-9

Figure 6. Front panel.

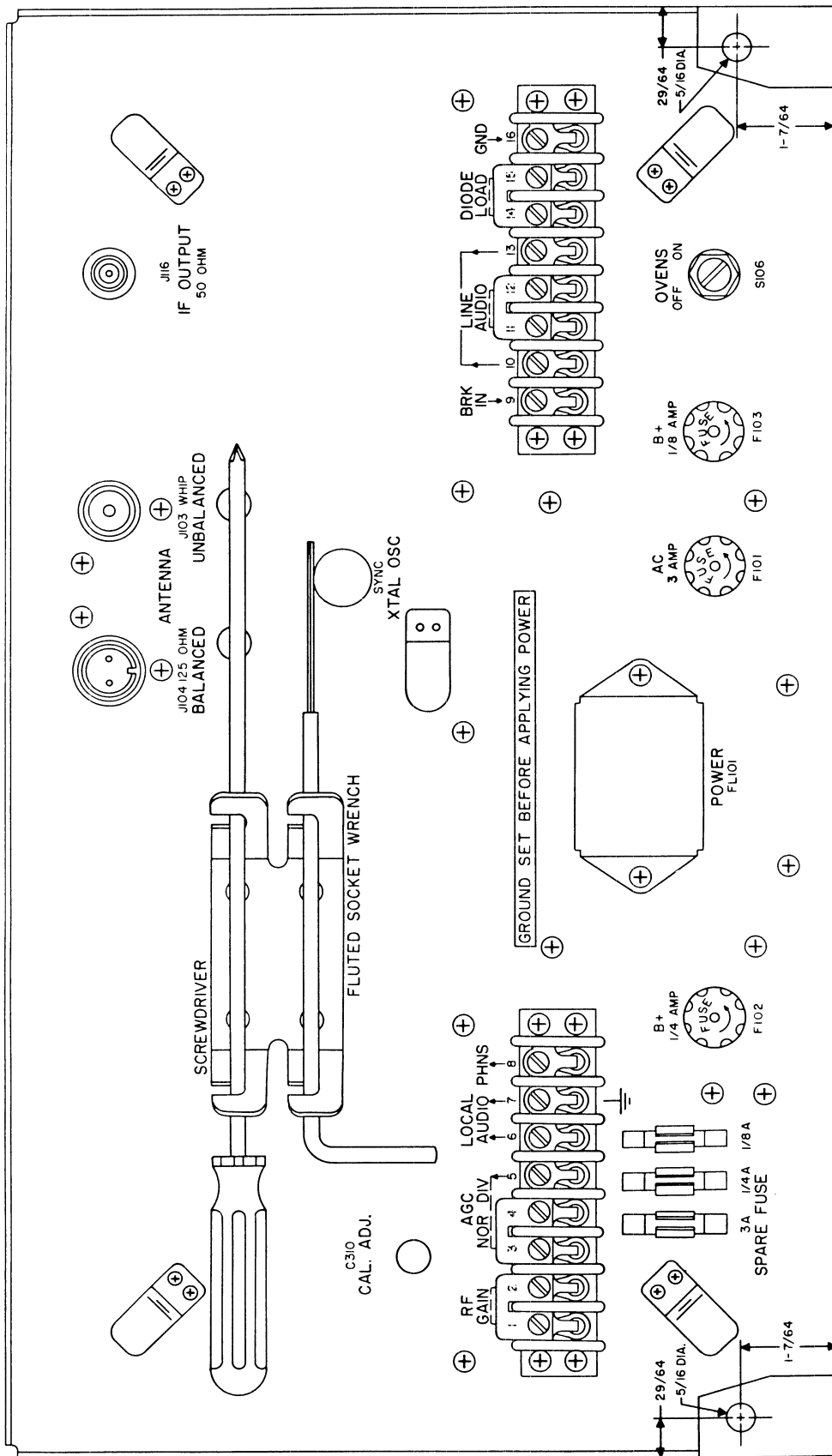

NOTE:
 FUSES F102 AND F103 APPEAR ONLY
 IN RECEIVERS BEARING ORDER NO.
 14-PHILA-56 SERIAL NUMBERS 2683
 AND ABOVE, AND ORDER NO. 14365-PHILA-58.

TM5820-358-10-10

Figure 7. Rear panel.

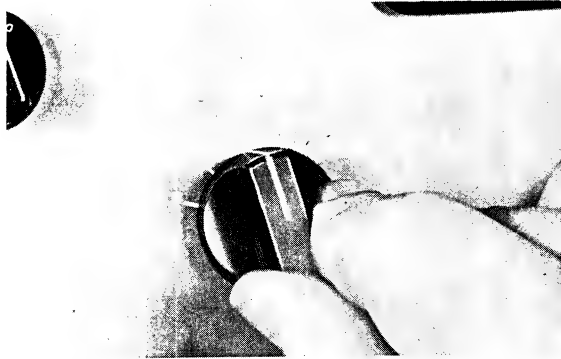

1 Turn the FUNCTION switch to AGC. Allow the receiver to warm up for several minutes before operating it.

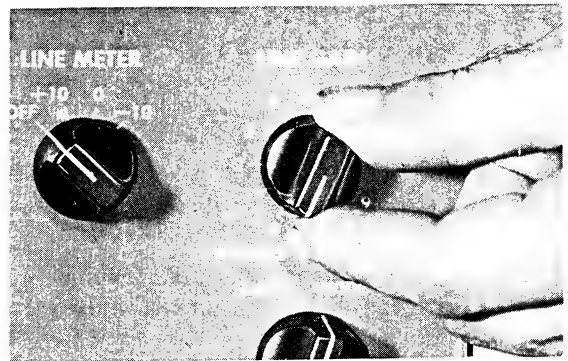

3 Turn the LINE GAIN to O.



2 Turn the BFO switch to OFF.



4 Turn the RF GAIN control to 10.



5 Turn the LOCAL GAIN control to 6.

TM5820-358-10-14 ①

Figure 8①. Preparing receiver for reception (part 1 of 2).

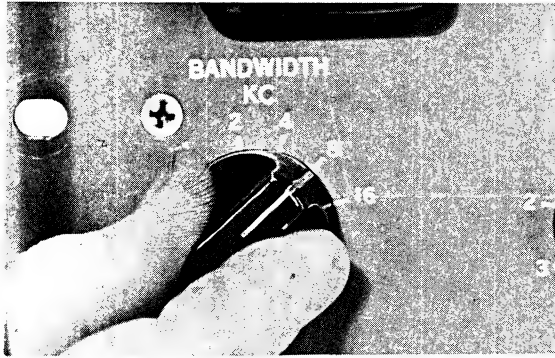

6 Turn the BANDWIDTH switch to 8.



8 Turn the AGC switch to MED.

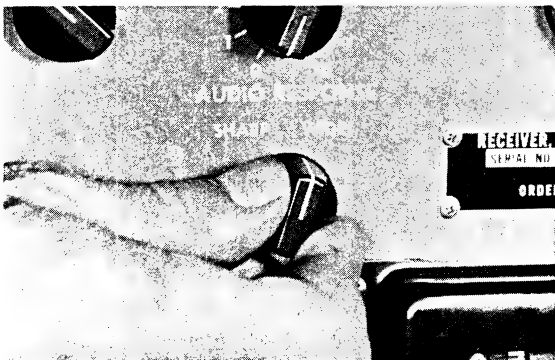

7 Turn the AUDIO RESPONSE switch to WIDE.



9 Turn the LIMITER control to OFF.

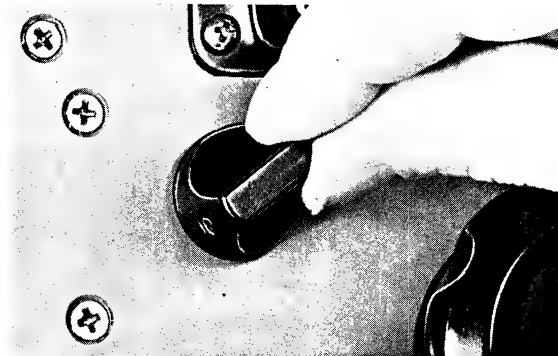

10 Turn the DIAL LOCK to the left until it stops.

TM5820-358-10-14 (2)

Figure 8②. Preparing receiver for reception (part 2 of 2).

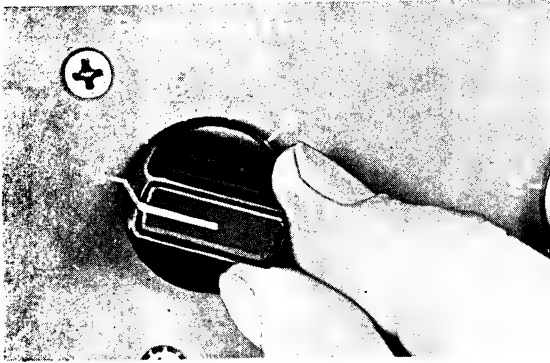

1 Turn the BANDWIDTH switch to .1.

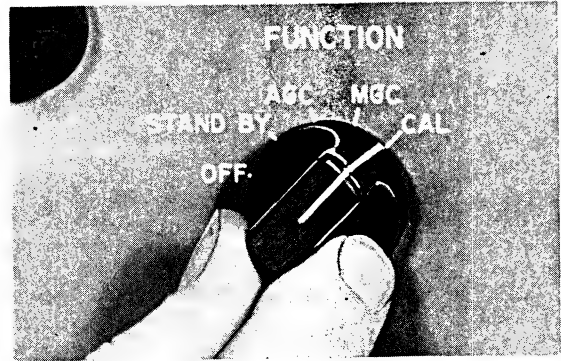

4 Turn the FUNCTION switch to CAL.

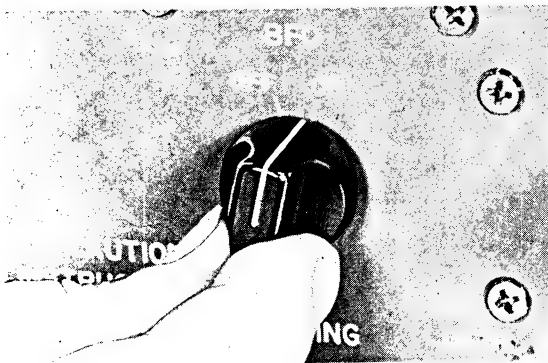

2 Turn the BFO switch to ON.

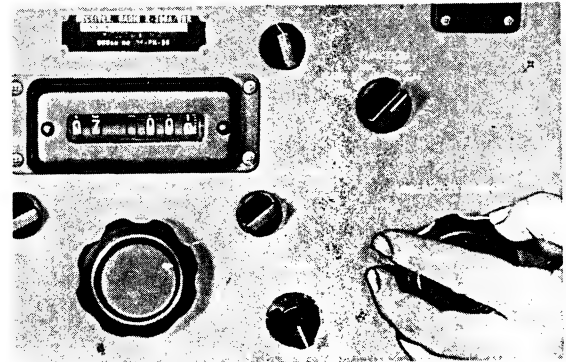

5 Turn the MEGACYCLE CHANGE control to the desired band.

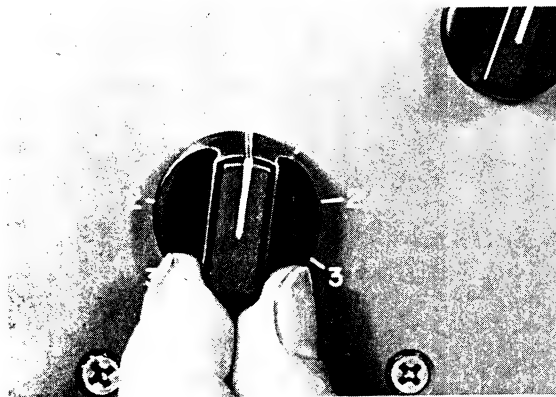

3 Turn the BFO PITCH control to 0.



6 Turn the KILOCYCLE CHANGE control to the 100-kc point nearest the desired frequency.

TM5820-358-10-15 ①

Figure 9①. Calibration (part 1 of 2).



7 Turn the ZERO ADJ knob to the right until it stops.



8 Adjust the ANT TRIM knob to obtain a maximum indication of the CARRIER LEVEL meter.

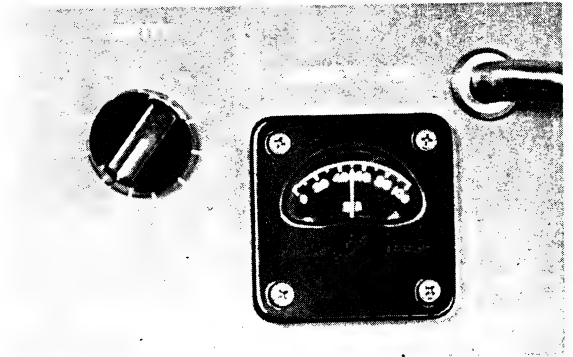

9 Adjust the KILOCYCLE CHANGE control for a maximum indication of the CARRIER LEVEL meter (step 6).

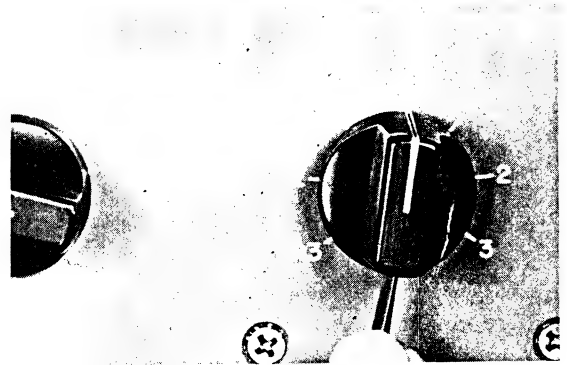

10 If the BFO PITCH control does not produce a zero beat at 0, tune it for zero beat, loosen the knob screw, and adjust the knob to zero without turning the shaft. Tighten the knob screw.

11 Turn the ZERO ADJ knob to the left until it stops. The dial is now calibrated accurately (step 7).

TM5820-358-10-15 (2)

Figure 9②. Calibration (part 2 of 2).

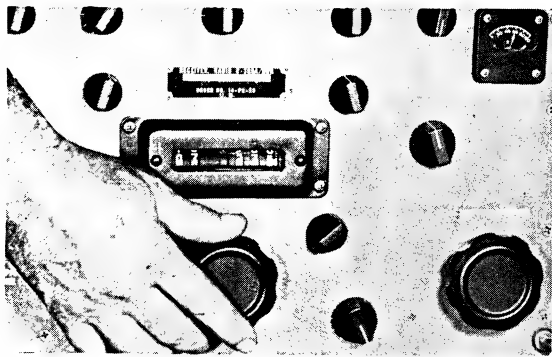

1 Turn the KILOCYCLE CHANGE control slightly toward the left or right of the desired station for a maximum CARRIER LEVEL meter indication (the MEGACYCLE CHANGE control has been set during calibration).



3 Turn the DIAL LOCK knob to the right until it stops.

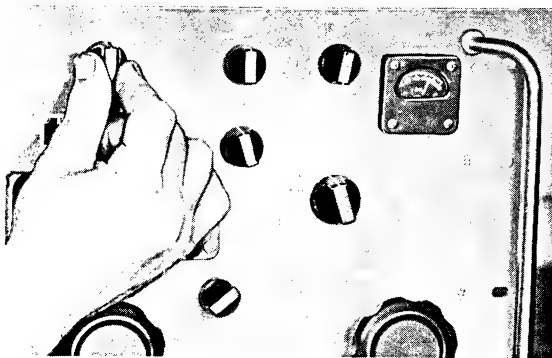

2 Adjust the ANT TRIM control for a maximum CARRIER LEVEL meter indication.



4 Adjust the LOCAL GAIN control for a comfortable volume level.

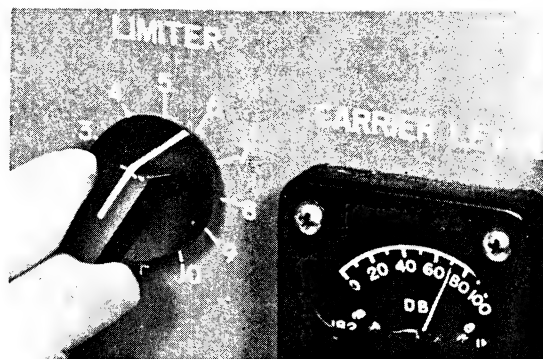

5 If there is excessive noise, turn the LIMITER control to the right as needed.

TM 5820-358-10-16 ①

Figure 10①. Tuning receiver for voice reception (part 1 of 2).

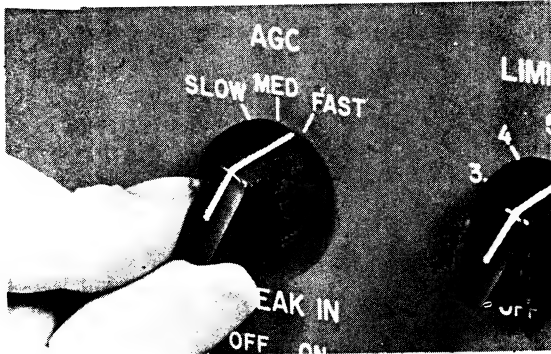

6 If the signal fades rapidly, turn the AGC control to FAST.

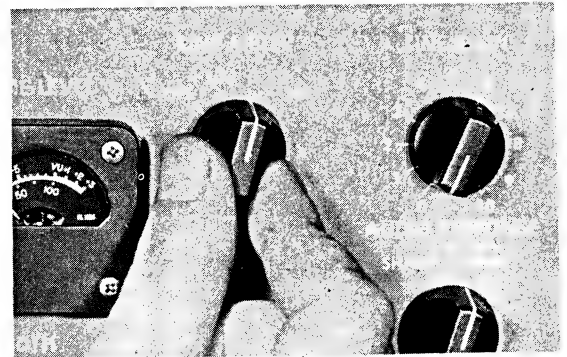

8 The LINE METER switch (when used) is usually set at 0.



7 If another station is interfering, turn the BANDWIDTH switch to 4, or if necessary to 2.

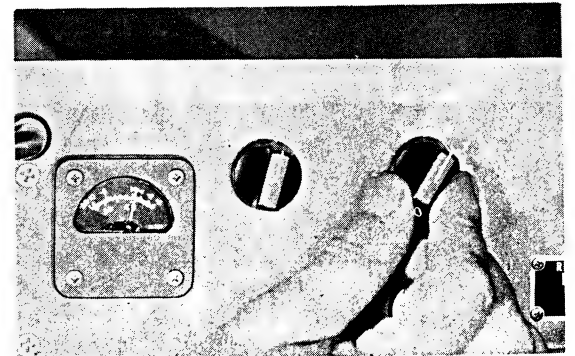

9 When the LINE METER switch is set at 0, the LINE GAIN control is usually adjusted for a LINE LEVEL meter indication at the VU mark.

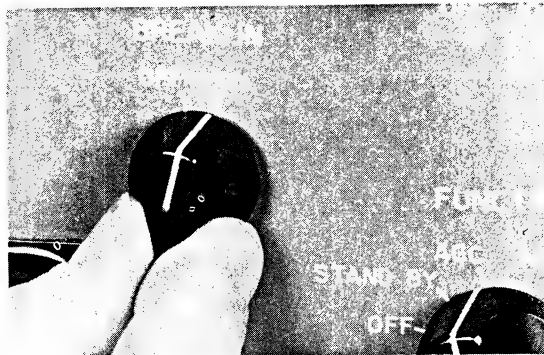

10 If the receiver is to be disabled during periods of transmission, turn the BREAK IN switch to ON.

TM5820-358-10-16 (2)

Figure 10. Tuning receiver for voice reception (part 2 of 2).



1 Turn the BFO switch to ON.

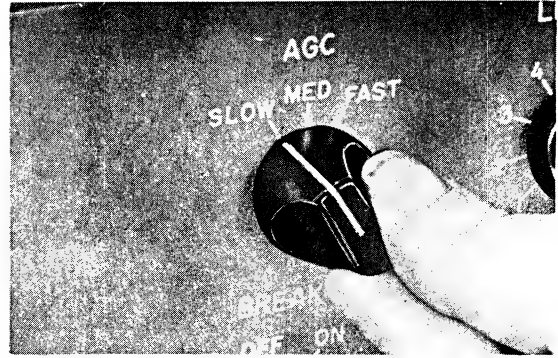

4 Turn the AGC switch to SLOW. If keying is at such a slow speed that noise is heard between characters, perform steps 5 and 6.



2 Adjust the BFO PITCH control for a comfortable tone.

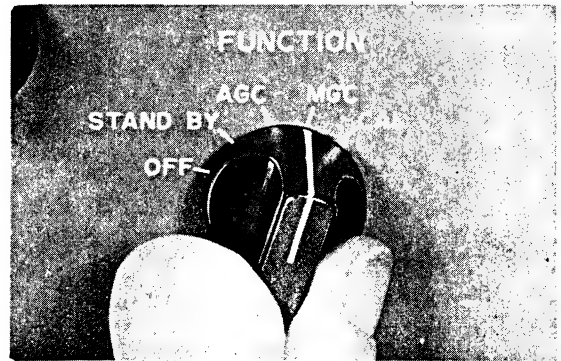

5 Turn the FUNCTION switch to MGC.



3 Turn the BANDWIDTH switch to 2, or if necessary to a lower position, to reduce adjacent channel interference.



6 Reduce the RF GAIN control setting to prevent blocking. For greater selectivity during cw reception, perform steps 7, 8, 9, 10, and 11.

TM5820-358-10-17①

Figure 11①. Mcw or cw reception (part 1 of 2).



7 Turn the BANDWIDTH switch to .1.



9 Tune the KILOCYCLE CHANGE control for zero beat.

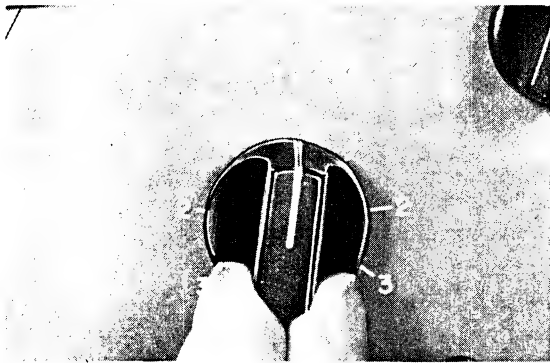

8 Turn the BFO PITCH control to 0.



10 Adjust the BFO PITCH control for a comfortable tone.

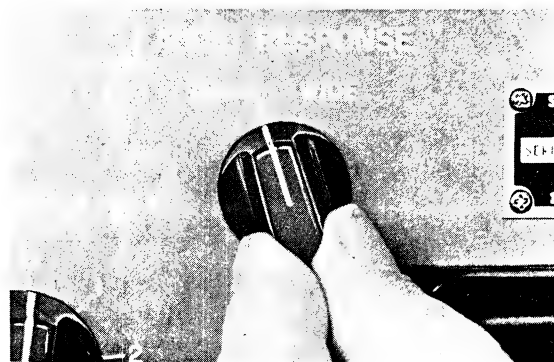

11 Turn the AUDIO RESPONSE switch to SHARP.

TM5820-358-10-17 (2)

Figure 11 (2). Mcw or cw reception (part 2 of 2).

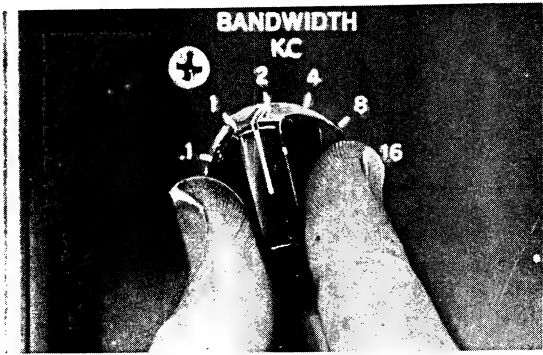

1 Turn the BANDWIDTH switch to 2. (For filter-type equipment, such as Radioteletype Terminal Equipment AN/FGC-1, where audio frequencies of 2,125 and 2,975 cps are used, turn the BANDWIDTH switch to 4.)

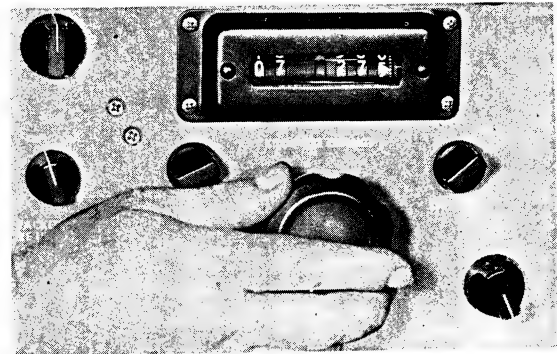

3 Tune the KILOCYCLE CHANGE control to the desired frequency; then readjust it slightly until mark and space signals with the same tone are heard.



2 Turn the FUNCTION switch to AGC.



4 Adjust the BFO PITCH control until the teletypewriter prints good copy.

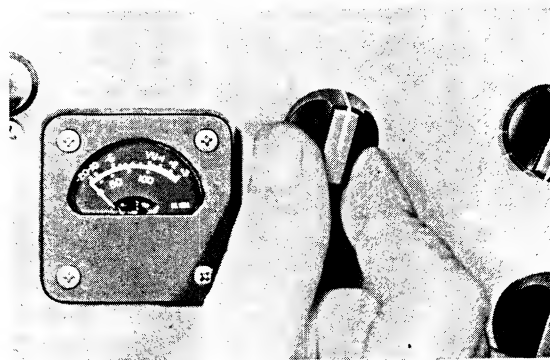

5 Turn the LINE METER switch to 0.

TM 5820-358-10-18 ①

Figure 12①. Reception of frequency-shift signals (part 1 of 2).

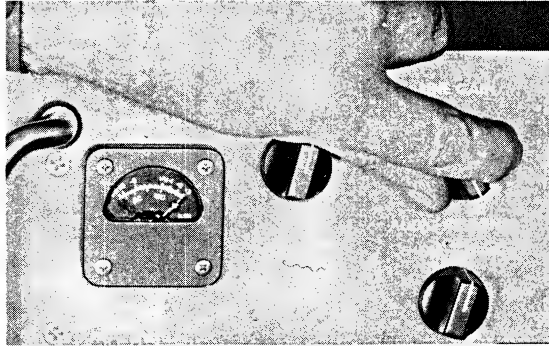

6 Turn the LINE GAIN control to 10. The LINE LEVEL meter should deflect fully to the right.

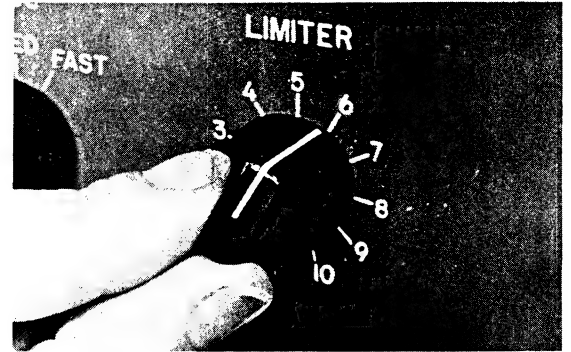
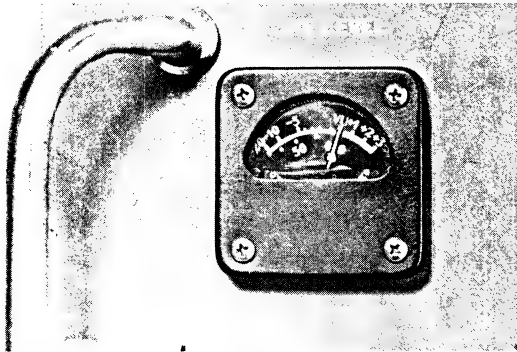

7 Adjust the LIMITER control for a LINE LEVEL meter indication at the VU mark.

TM5820-358-10-18 (2)

Figure 12(2). Reception of frequency-shift signals (part 2 of 2).



1 Turn the FUNCTION switch to MGC.



3 Turn the LOCAL GAIN control to 6.



2 Turn the RF GAIN control to 6.

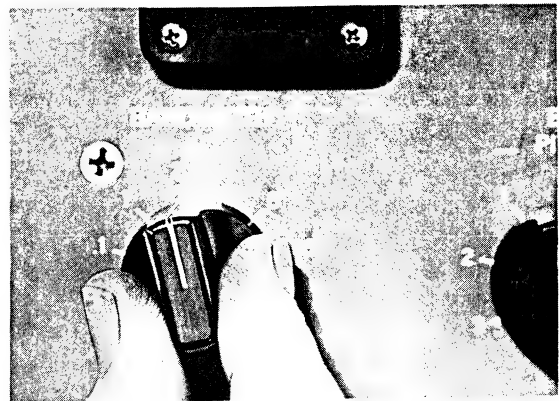

4 Turn the BANDWIDTH switch to 2 for a 2-kc bandwidth, or to 4 for a 4-kc bandwidth.

TM5820-358-10-19 ①

Figure 13①. Single-sideband reception (part 1 of 2).



- 5** Turn the BFO switch to ON.



- 6** Set the BFO PITCH control at -1 for upper sideband reception with a signal 2-kc wide, or -2 for a 4-kc signal width ($+1$ or $+2$ respectively for lower sideband reception).

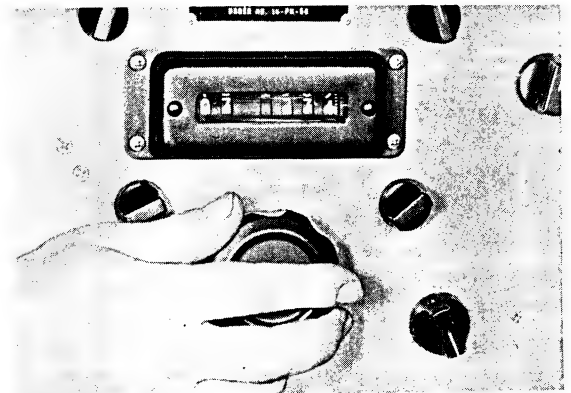

- 7** Tune the KILOCYCLE CHANGE control to the carrier frequency $+1$ kc for a 2-kc bandwidth, or $+2$ kc for a 4-kc bandwidth if the upper sideband is used (-1 kc or -2 kc respectively if the lower sideband is used).

- 8** Adjust the BFO PITCH and/or KILOCYCLE CHANGE control slightly for the most intelligible reception (steps 6 and 7).

- 9** Adjust the LOCAL GAIN and RF GAIN controls for the desired audio level (steps 2 and 3).

TM5820-358-10-19 (2)

Figure 13(2). Single-sideband reception (part 2 of 2).

17. Stopping Procedure

When the receiver is not to be used but is to be maintained in a state of readiness, turn the FUNCTION switch to STAND BY.

Caution: The FUNCTION switch should not be left in STAND BY for more than 30 minutes. Under this condition, the life of certain vacuum tubes may be shortened. For stopping procedure, refer to figure 14.

18. Antijamming Instructions

When it is determined that the receiver is being jammed, promptly inform your immediate superior officer. To provide maximum intelligibility of jammed signals, use the procedures given for each type of operation.

a. When receiving jammed voice signals, follow the procedures in the order indicated below until the signal is heard with the least amount of interference.

- (1) Turn the KILOCYCLE CHANGE control very slowly through several dial markings on either side of the desired signal. Some separation of the desired signal from the jamming signal may be achieved.

- (2) Turn the BANDWIDTH switch to 4 or 2, whichever gives better results. Slowly tune as described in (1) above.
- (3) Adjust the ANT TRIM control to the point where the signal is heard with the least amount of interference.
- (4) If the noise is severe, adjust the LIMITER control as required.
- (5) When the jamming signal is weak, turn the FUNCTION switch to MGC and the RF GAIN control counterclockwise. The interfering signal may be reduced enough to permit the desired signal to come through.
- (6) If these steps do not provide a readable signal, request a change of frequency and call sign.
- (7) Request the use of cw operation, if permissible (b below).
- (8) If possible, change the direction, length, and height of the antenna. This may reduce the jamming effectiveness so that some degree of satisfactory reception is obtained.
- (9) If the jamming prevents communication, report this fact to your immedi-



1 When the receiver is not to be used but is to be maintained in a state of instant readiness, turn the FUNCTION switch to STAND BY.

Caution: Do not leave the FUNCTION switch in STAND BY for more than 30 minutes, because the life of certain vacuum tubes may be shortened.



2 To shut the receiver off, turn the FUNCTION switch to OFF.

TM 5820-358-10-20

Figure 14. Stopping procedure.

ate superior. Keep your receiver tuned to the desired signal; continue to operate.

b. When receiving jammed cw or mcw signals, follow the procedures in the order indicated below until satisfactory reception is established.

- (1) Turn the KILOCYCLE CHANGE control very slowly through a few dial markings on either side of the desired signal. Some separation of the desired signal from the jamming may be achieved.

- (2) Turn the BANDWIDTH switch to 1 or .1 and turn the AUDIO RESPONSE switch to SHARP. Slowly tune as described in (1) above.

- (3) Reset the BFO PITCH control; it may be possible to separate the tone of the desired signal from the jamming signal to provide readability.

- (4) Perform the procedures indicated in *a*(3) through (6), (8), and (9) above.

c. When receiving frequency-shift signals, refer to the technical manual on the particular receiving system for antijamming instructions.

CHAPTER 3

MAINTENANCE INSTRUCTIONS

19. Scope of Operator's Maintenance

a. The following is a list of maintenance duties normally performed by the operator of Radio Receiver R-390A/URR. These procedures do not require special tools or test equipment.

b. Operator's maintenance for Radio Receiver R-390A/URR consists of the following:

- (1) Preventive maintenance (para 20).
- (2) Visual inspection (para 22).
- (3) Operational check (para 23).
- (4) Replacement of defective fuses (para 21).

20. Preventive Maintenance

a. *DA Form 11-238*. DA Form 11-238 (fig. 15) is a preventive maintenance checklist to be used by the operator. Items not applicable to the receiver are lined out in the figure. References in the ITEM block in the figure are to paragraphs that contain additional maintenance information pertinent to the particular item. Instructions for the use of the form appear on the form.

b. *Items*. The information shown in the chart below is supplementary to DA Form 11-238. The item numbers correspond to the ITEM numbers on the form.

Item	Maintenance procedures
2	Use a clean cloth to remove dust, dirt, moisture, and grease from the exteriors of cases, racks, mounts, transmission lines, headsets, and front panel controls. If necessary, wet the cloth with Cleaning Compound (Federal stock No. 7930-395-9542) and then wipe the parts with a dry clean cloth.
3	All control knobs should work smoothly, be tight on the shaft, and should not bind. Tighten all loose knobs and be sure that the knobs do not rub against the panel.
7	Report to the higher echelon repairman any cut, worn, or broken cables, wires, or transmission lines.

Warning: Cleaning compound is flammable and its fumes are toxic. Do not use near a flame; provide adequate ventilation.

21. Checking Fuses

(fig. 7)

a. Remove the fuses from the rear panel. See that they are of the proper value. If the receiver is to be operated from a 115-volt source with the OVENS switch at OFF, replace the AC 3 AMP fuse with a 2-ampere fuse. If the receiver is to be operated from a 230-volt source with the OVENS switch at ON, use a 1½-ampere fuse; use a 1-ampere fuse with the OVENS switch at OFF.

Note. Receivers bearing Order No. 14-Phila-56, serial numbers 2683 and above, and Order No. 14385-Phila-58 have a ½-ampere and a ¼-ampere fuse on the rear panel in addition to the AC 3 AMP fuse.

b. If you replace a burned-out fuse with a new one and the new fuse burns out, notify a higher echelon repairman.

Caution: To avoid serious damage to the receiver, do not use any fuse other than the value specified.

22. Visual Inspection

a. When the equipment fails to perform properly, turn the power off and check all the items listed below. *Do not check any item with the power on.*

- (1) Wrong settings of switches and controls (para 9 and 10).
- (2) Cables, headset cord, or antenna lead-in wire improperly connected.
- (3) Disconnected cables, plugs, or headset cord.
- (4) Grounded or broken antenna lead-in wire.
- (5) Burned-out fuses (usually indicate some other faults) (para 21).

b. If the above checks do not locate the trouble, proceed to the operational checklist (para 23).

23. Operational Checklist

a. *General.* The operational checklist will help the operator to locate trouble quickly. The corrective measures are used to repair this

trouble. If the measures suggested do not restore normal operation, troubleshooting is required by a higher echelon repairman. Note on the repair tag what corrective measures were taken and how the equipment performed at the time of failure.

b. Procedure. Place the set in operation (para 13). After the equipment has had time to warm up, perform the steps shown in *c* below, in the order given. Observe the equipment operation and perform any corrective measures necessary.

c. Checklist

Action	Normal indication	Corrective measure
FUNCTION switch at AGC.	Dial lamps lighted.	Check power cord and fuses (para 21).
	Rushing noise or signal heard in headset.	Check headset cord and plug.
Turn MEGACYCLE CHANGE control to each band.	Proper numbers appear in frequency-indicator window.	Higher echelon repair required.
Tune KILOCYCLE CHANGE control to a desired station.	Desired station is heard.	Higher echelon repair required.
Adjust ANT TRIM control for a maximum indication on CARRIER LEVEL meter.	A maximum deflection of meter is obtained.	Higher echelon repair required.
Turn LOCAL GAIN control from minimum to maximum.	Volume at loudspeaker or headset will increase.	Higher echelon repair required.
Turn LINE GAIN control from minimum to maximum.	Output level to 600-ohm line or headset and LINE LEVEL meter will increase.	Higher echelon repair required.
Turn RF GAIN control from minimum to maximum.	Audio output and CARRIER LEVEL meter indication will increase.	Higher echelon repair required.
Turn FUNCTION switch to MGC.	With no signal being received, noise level should increase slightly and CARRIER LEVEL not indicate.	Higher echelon repair required.
Tune KILOCYCLE CHANGE control to several different signals with FUNCTION switch at AGC.	Output volume nearly constant.	Higher echelon repair required.
Turn FUNCTION switch to CAL and operate KILOCYCLE CHANGE control.	Deflection on CARRIER LEVEL meter at each 100 kc reading.	Higher echelon repair required.
Turn LIMITER control to the right.	Noise peaks are reduced in amplitude.	Higher echelon repair required.
Turn LINE METER switch to 0 and adjust LINE GAIN control for LINE LEVEL meter reading at VU mark.	LINE LEVEL meter reads at VU mark.	Higher echelon repair required.
LINE METER switch at -10.	LINE LEVEL meter reads completely to right.	Higher echelon repair required.
LINE METER switch at +10.	LINE LEVEL meter reads -10.	Higher echelon repair required.
LINE METER switch at OFF.	LINE LEVEL meter reads completely to left.	Higher echelon repair required.
Turn BFO switch to ON.		
Turn KILOCYCLE CHANGE control.	A whistle-like tone is heard as each station is tuned in.	Higher echelon repair required.
Turn BFO PITCH control.	The pitch of the tone changes.	Higher echelon repair required.

Action	Normal indication	Corrective measure
Turn BANDWIDTH KC switch to each position from 16 to .1.	Selectivity becomes sharper and noise decreases. Only low frequency audio tones are heard in the .1 position.	Higher echelon repair required.
Turn FUNCTION switch to STAND BY.	No noise or signal is heard, dial lamps remain lighted.	Higher echelon repair required.
Turn FUNCTION switch to OFF.	Dial lamps go out.	Higher echelon repair required.

CHAPTER 4

SHIPMENT AND LIMITED STORAGE AND DEMOLITION TO PREVENT ENEMY USE

Section I. SHIPMENT AND LIMITED STORAGE

24. Disassembly

The following instructions are recommended for preparing the receiver for transportation and storage:

- a. Disconnect the antenna lead-in cable.
- b. Remove all connections to the rear-panel terminal strips of the receiver.
- c. Unplug the headphone cord from the front panel PHONES jack.

d. Disconnect the power cable from the ac outlet. Wind the cable around the clips provided on the receiver rear panel.

25. Repacking for Shipment or Limited Storage

Repacking for shipment or limited storage is normally done at a higher echelon level.

Section II. DEMOLITION OF MATERIEL TO PREVENT ENEMY USE

26. Authority for Demolition

The receiver and its accessories will be demolished only upon the order of the commander. The destruction procedures outlined in paragraph 28 will be used to prevent the enemy from using or salvaging the equipment.

27. Methods of Destruction

Use any or all of the methods listed in *a* through *f* below to make the equipment completely useless.

a. *Smash*. Smash the controls, tuning mechanism, tubes, coils, switches, capacitors, transformers, filters, and meters; use sledges,

axes, handaxes, pickaxes, hammers, crowbars, or other heavy tools.

b. *Cut*. Cut the power cord, the antenna lead-in cable, and the headset cord; use an axe, a handaxe, or a machete.

c. *Burn*. Burn cords, cables, and manuals; use gasoline, kerosene, oil, flamethrowers, or incendiary grenades.

d. *Bend*. Bend the panel, the cabinet, and the main frame.

e. *Explosives*. If explosives are necessary, use firearms, grenades, or TNT.

f. *Disposal*. Bury or scatter the destroyed parts in slit trenches or foxholes, or throw them into streams.

APPENDIX I REFERENCES

Following is a list of applicable references that are available to the operator of Radio Receiver R-390A/URR:

DA PAM 108-1	Index of Army Motion Pictures, Film Strips, Slides, and Phono Recordings.	FM 21-5 FM 21-6	Military Training. Techniques of Military Instruction.
DA PAM 310-4	Index of Technical Manuals, Technical Bulletins, Supply Bulletins, Lubrication Orders, and Modification Work Orders.	FM 21-30 SR 320-5 SR 320-50 TM 11-649	Military Symbols. Dictionary of United States Army Terms. Authorized Abbreviations and Brevity Codes. Radio Receiving Sets AN/FRR-40 and AN/FRR-41.

APPENDIX II
BASIC ISSUE ITEMS LIST
RADIO RECEIVER R-390A/URR

Section I. INTRODUCTION

1. Scope

a. This appendix lists items supplied for initial operation and for running spares. The list includes tools, accessories, parts, and material issued as *part of* the major end item. The list includes all items authorized for basic operator maintenance of the equipment. End items of equipment are issued on the basis of allowances prescribed in equipment authorization tables and other documents that are a basis for requisitioning.

b. The columns are as follows:

- (1) *Source, maintenance, and recoverability code.* Not used.
- (2) *Federal stock number.* This column lists the 11-digit Federal stock number.
- (3) *Designation by model.* Not used.
- (4) *Description.* Nomenclature or the standard item name and brief identifying data for each item are listed in this column. When requisitioning, enter the nomenclature and description on the requisition.
- (5) *Unit of issue.* The unit of issue is the supply term by which the individual item is counted for procurement, storage, requisitioning, allowance, and issue purposes.

(6) *Expendability.* Expendable items are indicated by the letter X; nonexpendable items are indicated by NX.

(7) *Quantity authorized.* Under "Items Comprising an Operable Equipment" the column lists the quantity of items supplied for the initial operation of the equipment. Under "Running Spares and Accessory Items" the quantities listed are those issued initially with the equipment as spare parts. The quantities are authorized to be kept on hand by the operator for maintenance of the equipment.

(8) *Illustrations.* The "Figure No." column lists the illustrations in which the items appear. The "Item No." column lists the reference designations that appear on the part in the equipment. These designations are also used on any illustrations of the equipment.

2. Critical Items

A zero slash (ϕ) in the "Description" column indicates items that are expected to fail during the first year or items that will make the equipment inoperative if they fail.

Section II. FUNCTIONAL PARTS LIST

(1) SOURCE MAINTENANCE AND RECOVERABILITY CODE	(2) FEDERAL STOCK NUMBER	(3) DESIGNATION BY MODEL	(4) DESCRIPTION	(5) UNIT OF ISSUE	(6) EXPENDABILITY	(7) QUANTITY AUTHORIZED	(8) ILLUSTRATIONS	
							FIGURE NO	ITEM NO
			ITEMS COMPRISING AN OPERABLE EQUIPMENT					
			RECEIVER RADIO R-390A/URR					
	5820-538-7535		RECEIVER RADIO R-390A/URR	ea	X	1	5	V605
	Ord thru AGC		TECHNICAL MANUAL TM 11-3920-358-10	ea	X	2	5	V504
			RUNNING SPARES AND ACCESSORY ITEMS					
			RECEIVER RADIO R-390A/URR					
	5960-188-3564		0 ELECTRON TUBE: MIL type 6A2	ea	X	1	5	V603
	5960-188-3551		0 ELECTRON TUBE: MIL type 6AK6	ea	X	1	5	V604
	5960-188-8315		0 ELECTRON TUBE: MIL type 6C1 Item Nos. V502, V203, V201, V606	ea	X	1	5	V601
	5960-548-5068		0 ELECTRON TUBE: MIL type 6DD6	ea	X	1	5	See desc column
	5960-262-0221		0 ELECTRON TUBE: MIL type 2A25W	ea	X	1	5	V801
	5960-262-1357		0 ELECTRON TUBE: MIL type 5A53 6AK5A	ea	X	1	5	V802
	5960-264-2089		0 ELECTRON TUBE: MIL type 5710 6AV6W; (When V701 is replaced sub-assembly must be adjusted)	ea	X	2	5	V207
	5960-262-0210		0 ELECTRON TUBE: MIL type 5811A Item Nos. V501, V503, V503, V505, V508, V701	ea	X	2	5	V101
	5920-010-6652		0 FUSE, CARTRIDGE: MIL type F026R091 Item Nos. V205, V206, V506, V707, V509, V601, V602	ea	X	5	5	See desc column
	5920-543-0425		0 FUSE, CARTRIDGE: MIL type F026R250B	ea	X	5	5	F101
	5920-356-2188		0 FUSE, CARTRIDGE: MIL type F026R125A	ea	X	5	5	F102
	6240-155-7857		0 LAMP, TV-ANODESCENT: Fed Spec No. W-L-11, Trade No. 320; Collins part/fig No. 263 0023 00	ea	X	1	5	F103
			0 LAMP, GLOW: 1 1/2, GE type No. NE-45	ea	X	1	5	I102
	59 05 - 502 - 4840		RESISTOR, CURRENT REGULATING MIL TYPE T031M01 6210-170-1811 (Eng Stk No.)	ea	X	1	5	I103
				ea	X	1	5	RT510

R-390A/URR

TM 5820-358-10-21

By Order of *Wilber M. Brucker*, Secretary of the Army:

G. H. DECKER,
General, United States Army,
Chief of Staff.

Official:

R. V. LEE,
Major General, United States Army,
The Adjutant General.

Distribution:

Active Army:

To be distributed in accordance with DA Form 12-7 requirements for TM 11 Series (UNCL) plus the following formula:

USASA (2)	11-57
CNGB (1)	11-85
Tech Stf, DA (1) except CSigO (18)	11-86
DASA (5)	11-98
US ARADCOM (2)	11-117
US ARADCOM Rgn (2)	11-155
MDW (1)	11-500 (AA-AE) (4)
Seventh US Army (2)	11-557
EUSA (2)	11-587
Units org under fol TOE: (2 copies each	11-592
except as inde)	11-597
11-7	32-51
11-16	32-56
11-32	32-57

NG: State AG (3); Units — Same as Active Army except allowance is one copy for each unit.

USAR: None.

For explanation of abbreviations used, see AR 320-50.



