

TM 9-1893A

RESTRICTED*

WAR DEPARTMENT

TECHNICAL MANUAL



ORDNANCE MAINTENANCE

**ENGINE, ENGINE ACCESSORIES, AND CLUTCH
FOR CARGO CARRIER M28 (T15)**

14 SEPTEMBER 1943

**Dissemination of restricted matter.—The information contained in restricted documents and the essential characteristics of restricted materiel may be given to any person known to be in the service of the United States and to persons of undoubted loyalty and discretion who are cooperating in Government work, but will not be communicated to the public or to the press except by authorized military public relations agencies. (See also paragraph 18b, AR 380-5, 28 September 1942.)*

RESTRICTED*

U 113
2
TM 9-1893A
1943
★ ★

TM 9-1893A

TECHNICAL MANUAL }
No. 9-1893A }

WAR DEPARTMENT
Washington, 14 September 1943

ORDNANCE MAINTENANCE
ENGINE, ENGINE ACCESSORIES, AND CLUTCH
FOR CARGO CARRIER M28 (T15)

Prepared under the direction of the
Chief of Ordnance
(with the cooperation of The Studebaker Corporation)

**Dissemination of restricted matter.—The information contained in restricted documents and the essential characteristics of restricted material may be given to any person known to be in the service of the United States and to persons of undoubted loyalty and discretion who are cooperating in Government work, but will not be communicated to the public or to the press except by authorized military public relations agencies. (See also paragraph 18b, AR 380-5, 28 September 1942.)*

CONTENTS

	Paragraphs	Pages
CHAPTER 1. INTRODUCTION	1-3	4-11
CHAPTER 2. ENGINE	4-59	12-72
SECTION I Description and data.....	4-5	12-15
II Trouble shooting	6	16-18
III Removal	7	19-24
IV Cleaning and inspection.....	8-9	24
V Removal of accessories.....	10-21	25-26
VI Disassembly	22	27-33
VII Cleaning of engine parts.....	23	34-36
VIII Inspection of engine parts.....	24-42	37-49
IX Repair and rebuilding.....	43-44	50-53
X Assembly	45	54-63
XI Installation of accessories.....	46-57	64-67
XII Installation and test of engine....	58	68-70
XIII Fits and tolerances.....	59	71-72

**ORDNANCE MAINTENANCE — ENGINE, ENGINE ACCESSORIES,
AND CLUTCH FOR CARGO CARRIER M28 (T15)**

	Paragraphs	Pages
CHAPTER 3. FUEL SYSTEM	60-90	73-99
SECTION I Description and data	60-61	73
II Trouble shooting on fuel system . .	62	74
III Carburetor	63-69	75-87
IV Fuel pump	70-77	88-94
V Fuel tank	78-84	95-97
VI Primer	85-89	98-99
VII Fits and tolerances	90	99
CHAPTER 4. MANIFOLD AND EXHAUST SYSTEM. 91-105	91-105	100-105
SECTION I Description and data	91-92	100
II Trouble shooting	93	100-101
III Manifold	94-100	101-103
IV Exhaust pipes and muffler	101-104	103-105
V Fits and tolerances	105	105
CHAPTER 5. IGNITION AND ELECTRICAL		
SYSTEMS	106-113	106-109
SECTION I Ignition system	106-110	106-108
II Electrical system	111-113	109
CHAPTER 6. COOLING SYSTEM	114-138	110
SECTION I Description and data	114-115	110-111
II Trouble shooting	116	111-112
III Radiator	117-121	113-114
IV Fan, pulley and belt	122-126	115-117
V Water pump	127-133	117-120
VI Engine water thermostat	134-137	120-121
VII Fits and tolerances	138	122
CHAPTER 7. CLUTCH	139-166	123
SECTION I Description and data	139-140	123-124
II Trouble shooting	141	125
III Clutch housing	142-147	126-129
IV Clutch cover with pressure plate . .	148-154	129-136
V Clutch driven plate with facings . .	155-161	136-137
VI Clutch control and linkage	162-165	138-139
VII Fits and tolerances	166	140
CHAPTER 8. SPECIAL TOOLS	167	141
SECTION I Special tools	167	141
REFERENCES		142
INDEX		144

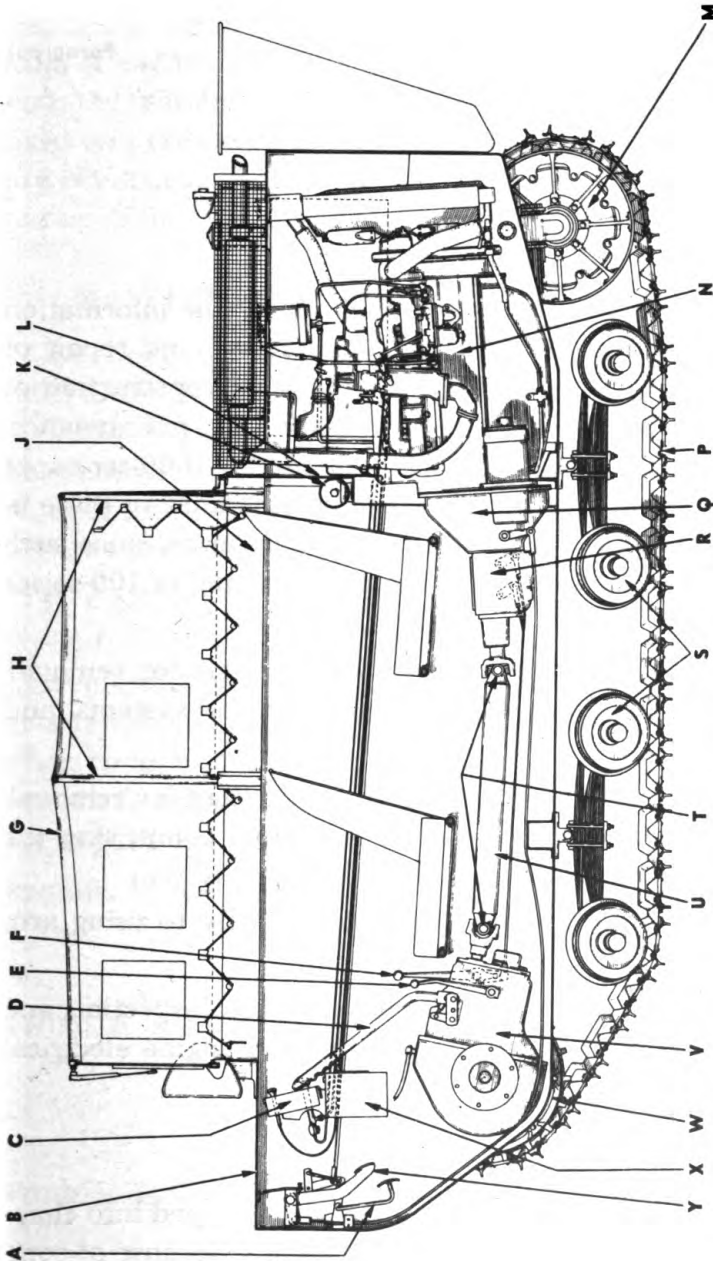

- | | | |
|---|-----------------------------|--|
| A —ACCELERATOR PEDAL | H —TOP BOW | R —TRANSMISSION |
| B —VEHICLE DECK | J —DECK COAMING | S —BOGIE WHEEL |
| C —INSTRUMENT PANEL | K —FIRE EXTINGUISHER | T —PROPELLER SHAFT UNIVERSAL JOINTS |
| D —STEERING LEVER | L —BULKHEAD | U —PROPELLER SHAFT |
| E —AXLE SHIFT LEVER | M —REAR WHEEL | V —AXLE UNIT |
| F —TRANSMISSION REMOTE CONTROL SHIFT LEVER | N —ENGINE | W —DRIVE WHEEL |
| G —TOP | P —TRACK | X —COMPASS |
| | Q —CLUTCH HOUSING | Y —CLUTCH PEDAL |

RA PD 314998

Figure 1—Cargo Carrier M28 (T15) Longitudinal Section

**ORDNANCE MAINTENANCE — ENGINE, ENGINE ACCESSORIES,
AND CLUTCH FOR CARGO CARRIER M28 (T15)**

CHAPTER 1

INTRODUCTION

	Paragraph
Scope	1
Arrangement	2
Maintenance allocation.....	3

1. SCOPE.

a. The instructions contained in this manual are for the information and guidance of personnel charged with the maintenance and repair of Cargo Carrier M28 (T15). Information on the detailed construction of the unit, disassembly and assembly procedure, inspection, maintenance, and repair is contained in two technical manuals of the 1000-series, of which this is volume A. These instructions are supplementary to those in the field and technical manuals prepared for the using arms, since such information is available to ordnance maintenance personnel in 100-series TM's or FM's.

b. This manual contains a description of, and procedure for, removal, disassembly, inspection, and repair of the engine, engine systems, and clutch.

c. TM 9-1893B contains a description of, and procedure for, removal, disassembly, inspection, and repair of the various units comprising the power train, suspension system, hull, and hull electrical system.

d. TM 9-893 contains information directed primarily to using arm personnel.

e. TM 9-1825B contains instructions for disassembly, inspection, and repair of the various units comprising the ignition and engine electrical systems.

2. ARRANGEMENT.

a. The subject matter contained in this manual is grouped into chapters, the scope of each being indicated under "Contents." Because of complexity and length, one chapter is devoted to the engine and one to each system of the engine. Sections in each chapter are numbered consecutively within that chapter. Paragraphs are numbered consecutively throughout the manual.

b. Illustrations of specific operations support and clarify the descriptive matter in the text. Exploded views of the component parts of units show the correct relation of related parts and aid in identification. Figures

INTRODUCTION

are numbered consecutively throughout the manual and are located as near as possible to related text. Frequent references to applicable figures are made by number throughout the manual.

c. This manual differs from TM 9-893 in that, when referring to the engine as a unit, reference will be made to manifold side, or distributor side, of engine. The front end of the engine will be considered as the fan end; the rear end of the engine, as the flywheel end. References to engine parts will then coincide with nomenclature as used in SNL G-154, Standard Nomenclature List for the vehicle. Other references to left, right, front or rear of the vehicle are based on the driver's position as he sits in the seat.

3. MAINTENANCE ALLOCATION.

a. **Scope.** The scope of maintenance and repair by the crew and other units of the using arms is determined by the availability of suitable tools, availability of necessary parts, capabilities of the mechanics, time available, and tactical situation. All of these are variable and no exact system of procedure can be prescribed. Many second echelon operations are often done by ordnance personnel.

b. **Allocation of Maintenance.** Indicated below are the maintenance duties for which tools and parts have been provided for the using arm personnel. Other replacements and repairs are the responsibility of ordnance maintenance personnel but may be performed by using arm personnel when circumstances permit, within the discretion of the commander concerned. Echelons and words as used in this list of maintenance allocations are defined as follows:

SECOND ECHELON:	Line organization regiments, battalions, companies, detachments, and separate companies (first and second echelons).
THIRD ECHELON:	Ordnance light maintenance companies, ordnance medium maintenance companies, ordnance divisional maintenance battalions, and ordnance post shops.
FOURTH ECHELON:	Ordnance heavy maintenance companies, and service command shops.
FIFTH ECHELON:	Ordnance base regiments, ordnance bases, arsenals, and manufacturer's plants.
SERVICE (including preventive maintenance): Paragraph 23 a (1) and (2). AR 850-15.	Consists of servicing, cleaning, lubricating, tightening bolts and nuts, and making external adjustment of subassemblies or assemblies and controls.

**ORDNANCE MAINTENANCE — ENGINE, ENGINE ACCESSORIES,
AND CLUTCH FOR CARGO CARRIER M28 (T15)**

REPLACE: Paragraph 23 a (4). AR 850-15. Consists of removing the part, subassembly or assembly from the vehicles and replacing it with a new or reconditioned or rebuilt part, subassembly or assembly, whichever the case may be.

REPAIR: Paragraph 23 a (3) and (5) in part. AR 850-15. Consists of making repairs to, or replacement of the part, subassembly or assembly that can be accomplished without completely disassembling the subassembly or assemblies, and does not require heavy welding, or riveting, machining, fitting and/or alining or balancing.

REBUILD: Paragraph 23 a (5) in part and (6). AR 850-15. Consists of completely reconditioning and replacing in serviceable condition any unserviceable part, subassembly, or assembly of the vehicle, including welding, riveting, machining, fitting, alining, balancing, assembling and testing.

NOTE: Operations allocated will normally be performed in the echelon indicated by "X."

Operations allocated to the echelons indicated by "E" may be accomplished by the respective echelons in emergencies only.

NOTE: *The second echelon is authorized to remove and reinstall items marked by an asterisk. However, when it is necessary to replace an item marked by an asterisk with a new or rebuilt part, subassembly or unit assembly, the assembly marked by an asterisk may be removed from the vehicle by the second echelon *only after authority has been obtained from a higher echelon of maintenance.*

	ECHELONS			
CLUTCH	2nd	3rd	4th	5th
Clutch—replace	E	X		
Clutch—repair		X		
Clutch—rebuild			E	X
Controls and linkage—service and/or replace....	X			
Controls and linkage—repair.....		X		
Housing, clutch—replace.....		X		
Housing, clutch—rebuild.....			X	

COOLING GROUP

Connections—replace	X
Radiator assembly—replace	X

INTRODUCTION

ECHELONS

	2nd	3rd	4th	5th
Radiator assembly—repair		X		
Radiator assembly—rebuild			E	X
System, cooling—service	X			

DIFFERENTIAL ASSEMBLY

Bands, brake—service	X			
Bands, brake—replace and/or repair		X		
Controls and linkage—replace	X			
Controls and linkage—repair		X		
*Differential assembly—replace	*	X		
Differential assembly—repair		X		
Differential assembly—rebuild			E	X

ELECTRICAL GROUP

Battery—service, recharge and/or replace	X			
Battery—repair		X		
Battery—rebuild			E	X
Box, junction—replace	X			
Coil, ignition—replace	X			
Conduits and wiring—replace and/or repair	X			
Defroster assembly—replace	X			
Lamp assemblies—service and/or replace	X			
Lamp assemblies—repair		X		
Regulator, current and voltage—replace	X			
Regulator, current and voltage—service and/or repair		X		
Regulator, current and voltage—rebuild			X	
Switch assemblies—replace	X			
Switch assemblies—repair		X		

ENGINE

(STUDEBAKER CHAMPION)

Bearings, crankshaft (inserts)—replace		E	E	X
Belt—service and/or replace	X			
Block, cylinder—rebuild (recondition)			E	X
Carburetor assembly—replace	X			
Carburetor assembly—repair		X		
Carburetor assembly—rebuild			X	
Cleaner, air—service and/or replace	X			
Cleaner, air—repair		X		
Condenser, distributor—replace	X			

*See Note on Page 6.

**ORDNANCE MAINTENANCE — ENGINE, ENGINE ACCESSORIES,
AND CLUTCH FOR CARGO CARRIER M28 (T15)**

ECHELONS

	2nd	3rd	4th	5th
Controls and linkage—service and/or replace	X			
Controls and linkage—repair	X			
Crankshaft—rebuild (recondition)			E	X
Dilution system, engine oil—replace	X			
Dilution system, engine oil—repair		X		
Distributor assembly—service and/or replace . . .	X			
Distributor assembly—repair		X		
Distributor assembly—rebuild			X	
*Engine assembly—replace	*	X		
Engine assembly—repair		X		
Engine assembly—rebuild			E	X
Fan assembly—replace	X			
Fan assembly—repair		X		
Fan assembly—rebuild			X	
Filter assembly, oil—service and replace cartridge	X			
Filter assembly, oil—repair		X		
Flywheel—replace and/or repair		X		
Flywheel—rebuild (recondition)			E	X
Gaskets, cylinder head and manifold—replace . . .	X			
Gear train, timing—replace		X		
Generator assembly—replace and/or repair		X		
Generator assembly—rebuild			X	
Head, cylinder—replace and/or repair		X		
Lines and connections, oil (external)—replace . . .	X			
Lines and connections, oil (external)—repair . . .		X		
Lines and connections, oil (internal)—replace and/or repair		X		
Manifolds—replace	X			
Manifolds—repair		X		
Motor assembly—cranking—replace and/or repair		X		
Motor assembly—cranking—rebuild			X	
Pan assembly, oil—service and replace gaskets . . .		X		
Pan assembly, oil—repair and/or replace		X		
Pistons and rings—replace		E	E	X
Plugs, spark—service and/or replace	X			
Plugs, spark—(two-piece)—repair		X		
Points, breaker, distributor—replace	X			
Pump assembly, fuel—replace and/or repair		X		

*See Note on Page 6.

INTRODUCTION

ECHELONS

	2nd	3rd	4th	5th
Pump assembly, fuel—rebuild			X	
Pump assembly, oil—replace and/or repair		X		
Pump assembly, oil—rebuild			X	
Pump assembly, water—replace	X			
Pump assembly, water—repair		X		
Pump assembly, water—rebuild			X	
Rods, connecting—replace		E	E	X
Thermostat—replace	X			
Valves—service		X		
Ventilator, crankcase—service and/or replace	X			
Wiring, ignition—replace	X			

EXHAUST GROUP

Muffler and exhaust pipes—replace		X		
---	--	---	--	--

EXTINGUISHER, FIRE

Extinguisher, fire (carbon tetrachloride CC1 ₄) service (refill) and/or replace	X			
Extinguisher, fire (carbon tetrachloride CC1 ₄)— repair		X		
Extinguisher, fire (carbon tetrachloride CC1 ₄)— rebuild			E	X

FUEL GROUP

Filter assembly, fuel—service and/or replace	X			
Filter assembly, fuel—repair		X		
Lines and connections—replace	X			
Lines and connections—repair	E	X		
Pump assembly, primer—replace	X			
Pump assembly, primer—repair		X		
Pump assembly, primer—rebuild			X	
Tank—service and/or replace	X			
Tank—repair		X		

FINAL DRIVE

Final drive assembly—replace	X			
Final drive assembly—repair		X		
Final drive assembly—rebuild			E	X
Hub assemblies—replace	X			
Hub assemblies—repair		X		
Hub assemblies—rebuild			E	X
Shaft, axle—replace	X			
Shaft, axle—repair		X		

**ORDNANCE MAINTENANCE — ENGINE, ENGINE ACCESSORIES,
AND CLUTCH FOR CARGO CARRIER M28 (T15)**

ECHELONS

	2nd	3rd	4th	5th
Shaft, axle—rebuild (recondition)			E	X
Sprocket assembly, wheel—replace	X			
Sprocket assembly, wheel—repair		X		
Sprocket assembly, wheel—rebuild			E	X

HULL

Hull—repair		X		
Hull—rebuild			E	X
Seat—replace	X			
Seat—repair		X		
Windshield assembly—replace	X			
Windshield assembly—repair		X		
Wiper assemblies, windshield—replace	X			
Wiper assemblies, windshield—repair	E	X		
Wiper assemblies, windshield—rebuild			X	

INSTRUMENTS

Instruments—replace	X			
Instruments—repair		X		
Instruments—rebuild			E	X

SHAFTS, PROPELLER

Shaft assemblies, propeller (w/universal joints)—replace	X			
Shaft assemblies, propeller (w/universal joints)—repair		X		
Shaft assemblies, propeller (w/universal joints)—rebuild			E	X

SUSPENSION GROUP

Arm, idler rocker—replace	X			
Arm, idler rocker—repair		X		
Arm, idler rocker—rebuild			E	X
Axle assembly, rear—replace and/or repair		X		
Axle assembly, rear—rebuild			E	X
Bogie components—replace	X			
Bogie components—repair		X		
Bogie components—rebuild			E	X
Bracket assemblies, bogie—replace and/or repair		X		
Bracket assemblies, bogie—rebuild			E	X
Roller, track supporting—replace	X			

INTRODUCTION

ECHELONS

	2nd	3rd	4th	5th
Roller, track supporting—repair		X		
Roller, track supporting—rebuild			E	X
Track assemblies—replace	X			
Track assemblies—repair		X		
Track assemblies—rebuild			E	X
Wheel, bogie and idler—replace	X			
Wheel, bogie and idler—repair		X		
Wheel, bogie and idler—rebuild			E	X

TRANSMISSION

*Transmission assembly—replace	*	X		
Transmission assembly—repair		X		
Transmission assembly—rebuild			E	X

VEHICLE ASSEMBLY

Carrier, cargo—service	X			
Carrier, cargo—rebuild with serviceable unit assemblies			E	X

*See Note on Page 6.

**ORDNANCE MAINTENANCE — ENGINE, ENGINE ACCESSORIES,
AND CLUTCH FOR CARGO CARRIER M28 (T15)**

CHAPTER 2

ENGINE

Section I

DESCRIPTION AND DATA

	Paragraphs
Description and operation	4
Data	5

4. DESCRIPTION AND OPERATION.

a. The engine is a four-cycle, six-cylinder, L-head type, with 7 to 1 compression ratio, and is liquid-cooled. The crankshaft is of drop-forged construction with the counterbalancers forged as an integral part of the shaft. Four removable steel-backed bearings lined with micro-babbitt support the crankshaft. Connecting rod bearings are made of spun babbitt, which is bonded to the steel of the rod. The camshaft is of one-piece construction with all wearing surfaces case-hardened. Full-pressure lubrication is provided to all moving parts of the engine. Cast-iron, three-ring pistons are used. Valve tappet adjusting screws are self-locking and do not require the use of a locking nut.

b. Engine cooling is provided by a cooling solution circulated through internal passages in the cylinder block. A water pump, driven by the engine fan pulley belt, circulates the solution. Valves of silichrome steel are cooled by solution in passages surrounding the valve seats. Engine temperature is controlled by a thermostat located in the cylinder head.

c. A thermostatically operated heat control valve is located in the manifold to provide the correct amount of heat for the fuel and air mixture before delivery to the cylinders. Full automatic spark advance is incorporated in the ignition distributor.

5. DATA.

Make	Studebaker
Model	6-170
Type	L-head
Number of cylinders	6
Bore	3 in.
Stroke	4 in.

DESCRIPTION AND DATA

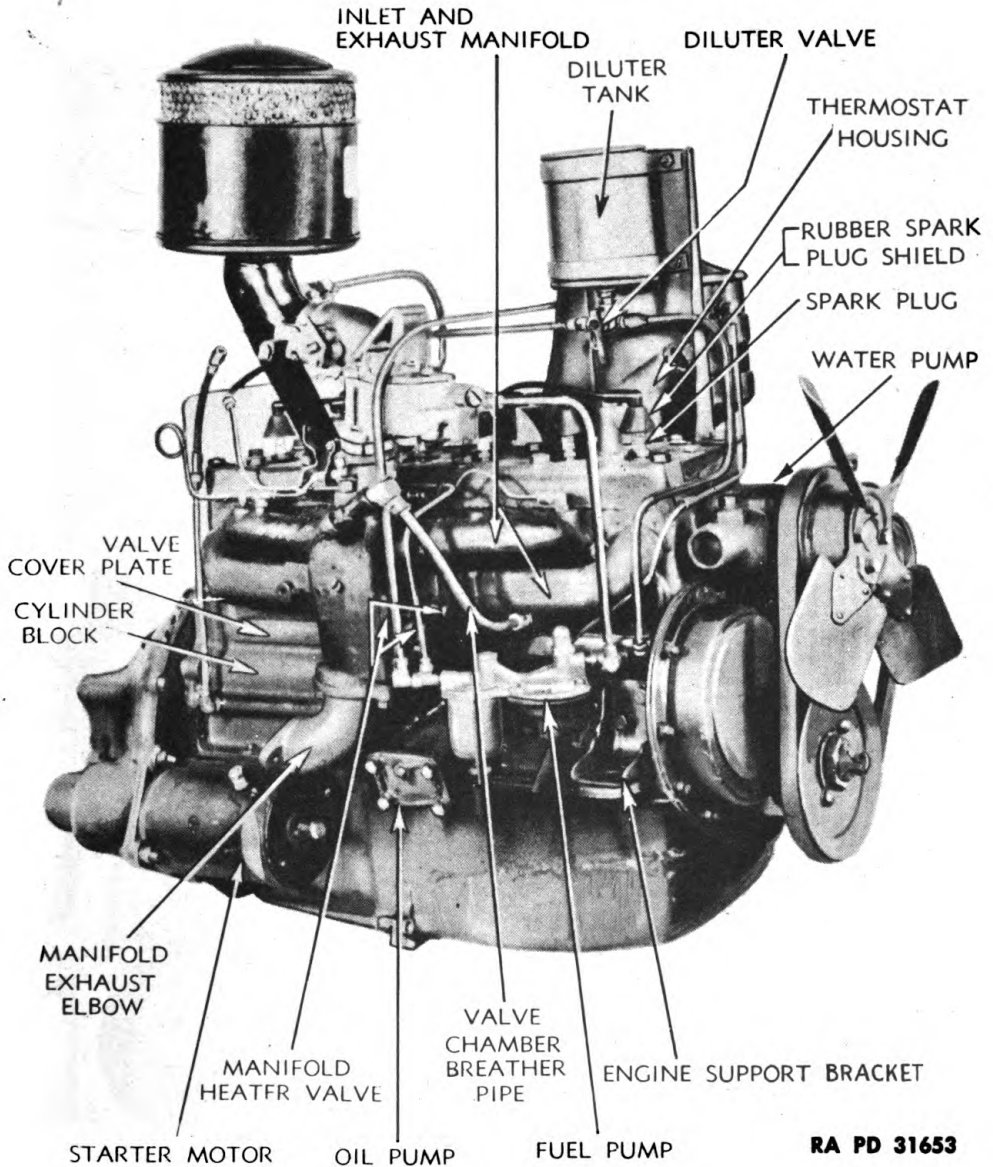

RA PD 31653

Figure 2—Engine—Manifold

Firing order	1-5-3-6-2-4
Displacement	169.6 cu in.
Compression ratio	7 to 1
Horsepower (net)	75 at 3800 rpm
Crankcase capacity	10½ qt
Piston material	Cast-iron
Piston rings	2 compression, 1 oil
Camshaft gear	Fiber
Manifold heat control	Automatic
Engine number location—	Stamped on machined pad at upper edge of
	cylinder block on distributor side of engine at No. 1 cylinder

**ORDNANCE MAINTENANCE — ENGINE, ENGINE ACCESSORIES,
AND CLUTCH FOR CARGO CARRIER M28 (T15)**

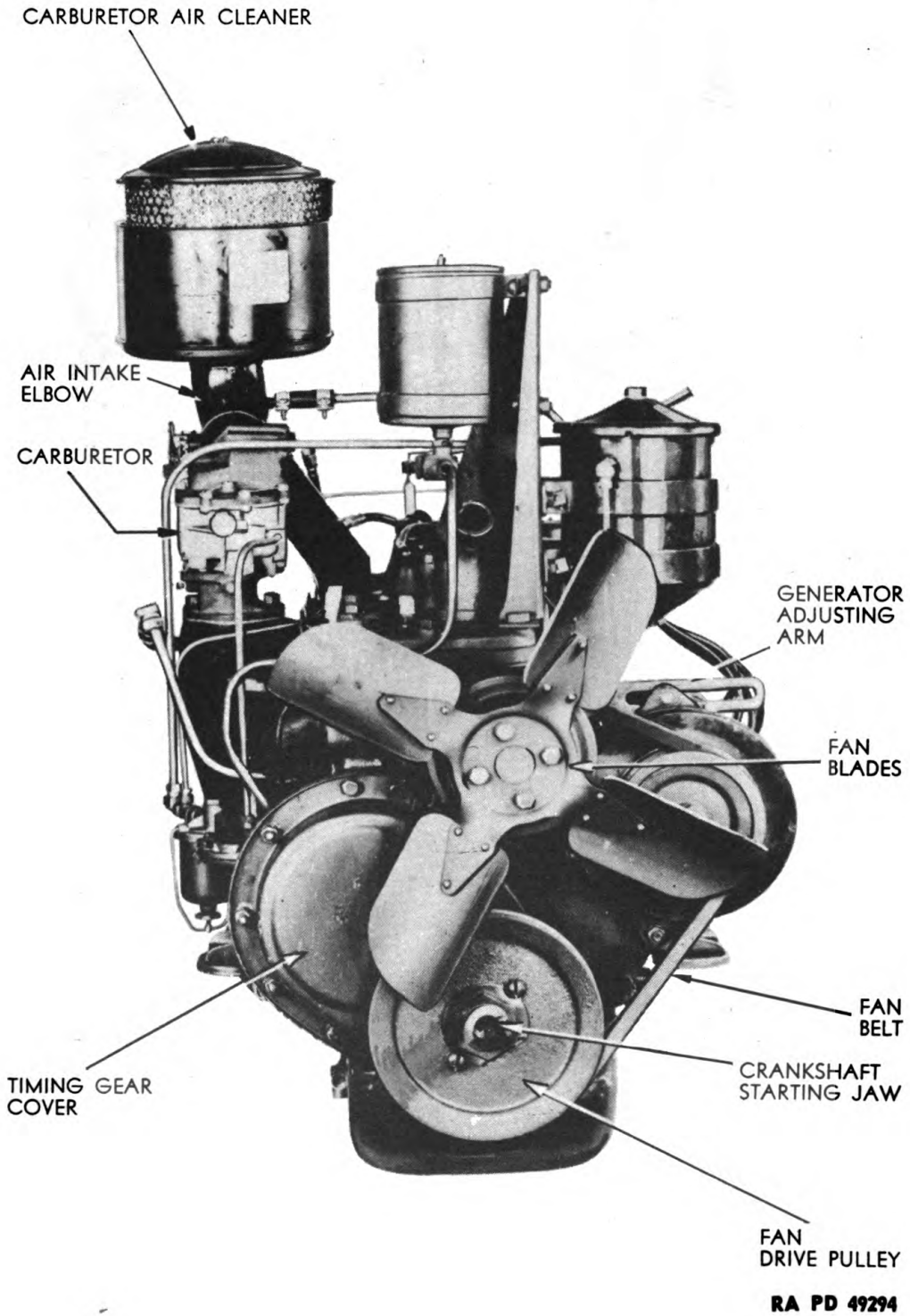

Figure 3—Engine—Front (Rear View)

DESCRIPTION AND DATA

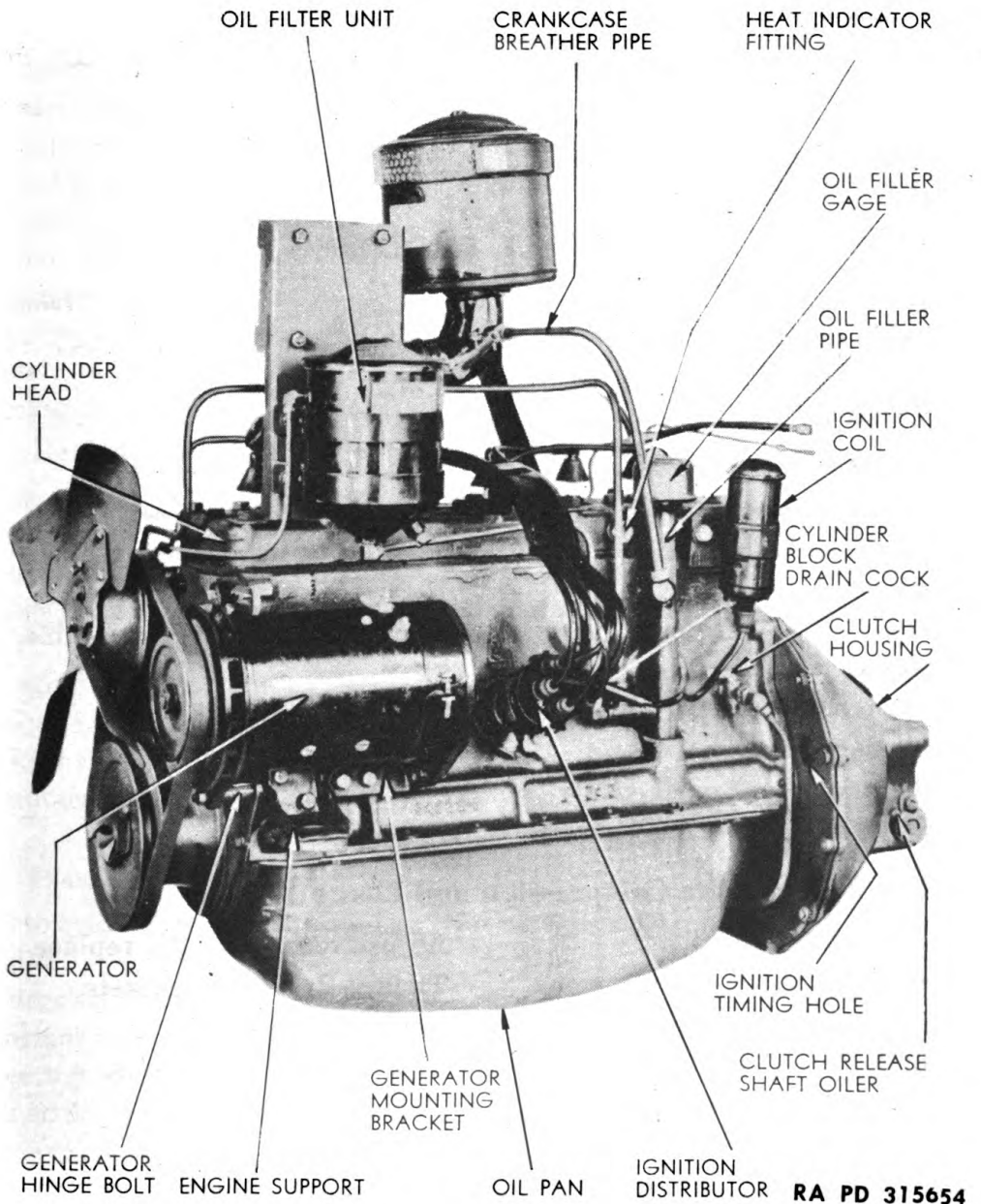

Figure 4—Engine—Distributor Side

**ORDNANCE MAINTENANCE — ENGINE, ENGINE ACCESSORIES,
AND CLUTCH FOR CARGO CARRIER M28 (T15)**

CHAPTER 2

ENGINE (Cont'd)

Section II

TROUBLE SHOOTING

Paragraph

Trouble shooting 6

6. TROUBLE SHOOTING.

a. Engine Starts Hard.

Possible Cause	Possible Remedy
Intake manifold leaks.	Tighten or install new gasket.
Battery low.	Recharge or replace battery.
Battery cable terminals loose or corroded.	Tighten, clean, or replace cable.
Ignition out of time.	Set ignition timing.
Condenser weak.	Replace condenser.
Distributor cover cracked.	Replace distributor cover.
Ignition switch contacts loose.	Replace switch.

b. Poor Engine Compression and Loss of Power.

Valves leaking.	Adjust, recondition, or replace.
Spark plug gaskets leak.	Tighten or replace gaskets.
Piston rings worn, stuck, or weak.	Replace rings.
Cylinder head loose.	Tighten head cap screws.
Cylinder head gasket leaking.	Replace gasket.
Pistons worn.	Replace worn parts.
Cylinders worn.	Recondition cylinders.
Valve springs weak or broken.	Replace springs.
Cylinder head cracked.	Replace cylinder head.

c. Engine Misfires, Engine Temperature Normal.

Intake manifold leaking.	Tighten or replace gasket.
Valves leaking.	Recondition or replace.
Piston rings leaking.	Replace.
Manifold heater valve shaft stuck.	Free or replace.
Water leaks into cylinders.	Determine cause and correct.

TROUBLE SHOOTING**d. Knocking.**

Possible Cause	Possible Remedy
Excessive main bearing clearance.	Replace main bearings.
Excessive crankshaft end play.	Adjust.
Main bearing misalignment.	Aline main bearings.
Insufficient oil supply.	Add oil.
Badly diluted oil.	Change oil.
Flywheel loose.	Tighten bolt nuts.
Crankshaft gear loose on shaft.	Tighten.
Excessive connecting rod bearing clearance (radial).	Replace rod.
Connecting rod misaligned.	Aline rod.
Eccentric, out of round, or tapered crankshaft journals.	Replace crankshaft.

e. Bearing Failures.

Bearing journal rough or out-of-round.	Replace crankshaft.
Oil passages restricted.	Clean passages.
Bearings loose or improperly fitted.	Replace main bearings or connecting rods.
Connecting rod bent.	Replace rod.
Improper grade or diluted oil.	Change oil.
Insufficient oil.	Add oil.
Continuous excessive engine speed.	Avoid continued operation at maximum speed.

f. Piston Noises.

Piston to cylinder bore clearance excessive.	Fit new piston.
Cylinders eccentric or tapered.	Recondition or replace.
Insufficient piston pin clearance.	Recondition or replace.
Connecting rod misalignment.	Aline rods.
Piston striking ridge at top of cylinder.	Remove ridge.
Piston striking carbon accumulation at top of cylinder.	Remove carbon.
Broken piston rings.	Replace rings.
Excessive ring clearance in ring groove.	Replace rings or pistons.
Excessive pin clearances.	Replace pin.
Locking pin loose in rod.	Tighten or replace.

g. Valves and Valve Lifter Noises.

Excessive valve stem to lifter clearance.	Adjust.
---	---------

**ORDNANCE MAINTENANCE — ENGINE, ENGINE ACCESSORIES,
AND CLUTCH FOR CARGO CARRIER M28 (T15)**

Possible Cause	Possible Remedy
Excessive clearance of lifter in guide.	Replace.
Valve springs weak.	Replace.
Valves sticking in guides.	Recondition.
h. Spark Knock or Preignition.	
Ignition timing too early.	Retime.
Excessive carbon deposits in engine.	Remove carbon.
Sharp metallic edges in combustion chamber.	Remove.
Cylinder head gasket projecting into combustion chamber.	Replace gasket.
Excessively hot engine valves.	Determine cause and correct.
i. Backfiring Through Carburetor.	
Improperly seating intake valves.	Recondition or replace.
Incorrect valve timing.	Retime.
Intake manifold air leaks.	Tighten or replace gaskets.
Defective cylinder head gasket.	Replace gasket.
j. Vibration.	
Unequal compression of engine cylinders.	Determine point of compression loss and correct.
Unbalanced or loose fan.	Tighten or replace.
Loose engine mountings.	Tighten.
Unbalanced or sprung crankshaft.	Replace.
k. Excessive Oil Consumption.	
Loss from external leaks.	Locate leak and correct.
Improper grade or diluted oil.	Change oil.
Excessive quantity of oil in crankcase.	Drain to proper level.
Excessive piston to cylinder wall clearance.	Recondition or replace engine.
Worn or stuck piston rings.	Recondition or replace engine.
Cylinder block distortion.	Replace block.
Excessive valve stem to guide clearance.	Replace guide.

CHAPTER 2
ENGINE (Cont'd)

Section III

REMOVAL

Paragraph

Remove engine 7

7. REMOVE ENGINE.

a. Remove Vehicle Top and Bows. Unfasten wires on vehicle top from windshield frame and deck coaming, and remove top. Take out cotter pins and lift top bows out of sockets, noting that bow having four eyelets at middle is installed in front.

b. Remove Seats. Unbuckle seat cushion straps and remove cushions. Take out screws, flat washers, and lock washers holding front seat to cockpit. Note the three possible front seat positions. Remove seat from cockpit. Take out cotter pins and clevis pins holding assistant driver's seat to cockpit side brackets. Lift seat out of brackets and remove it from cockpit.

c. Remove Propeller Shaft and Disconnect Transmission and Clutch Controls. Remove cap screws with flat washers and lock washers, and remove propeller shaft cover. Note that rectangular opening on one side of cover goes to right side. Remove the four U-bolt nuts, with lock washers, from front universal joint, and move propeller shaft assembly forward and off transmission mainshaft. Install a dummy flange, or pack rags around transmission mainshaft, to prevent lubricant leakage when engine is raised. Disconnect clutch and transmission remote control linkage by removing cotter pins and clevis pins. Remove clutch release shaft outer lever return spring.

d. Remove Engine Compartment Front Lid Screen. Unscrew and remove engine compartment front lid adjusting arm handwheel at each side, and move lid to a completely raised position. Remove three machine screws that secure front lid screen to brackets on engine compartment lid hinge support. Note that a lock washer and flat washer are used between nut and under side of bracket; also, a double toothed lock washer is used between screen and top side of bracket to assure complete grounding at these points. Repeat operation at the three screws holding front of screen to brackets on compartment front lid hinge.

e. Remove Engine Compartment Lid. Remove engine compartment lid and hinge support by taking out the four bolts and nuts with lock washers (two on each side) which hold lid hinge to deck coaming. Lift off lid and hinge assembly.

**ORDNANCE MAINTENANCE — ENGINE, ENGINE ACCESSORIES,
AND CLUTCH FOR CARGO CARRIER M28 (T15)**

f. **Remove Engine Compartment Front Lid and Hinge.** Remove lid cross bracket cap screws and lock washers at each end of bracket. Remove bolt, nut, lock washer, and flat washer securing each end of lid hinge and cross brackets to an angle bracket welded on the deck coaming. Remove cap screws, lock washers, and flat washers holding cross bracket to the bulkhead. Lift lid with hinge and cross bracket off vehicle.

g. **Remove Air Cleaner.** Loosen air cleaner throat clamp screw and remove carburetor air cleaner assembly.

h. **Remove Battery Compartment Cover and Disconnect Battery.** Remove bolts, nuts, flat washers, and lock washers holding battery compartment cover to deck rear coaming. Remove cap screws with flat washers and lock washers, fastening cover to engine compartment left quarter wall, shelf, and left deck coaming. Lift insulated battery compartment cover upward, to right, and out of engine compartment. Disconnect and remove battery ground strap clamp from negative (-) post on battery.

i. **Drain Cooling System.** Remove cooling system drain plate located on bottom of hull. After turning radiator cap to first stop to unseal cooling system, open drain valve at radiator outlet pipe located in lower left rear section of engine compartment. Also open engine block drain valve on right side of engine toward front. Loosen battery heater hose connection clamps and pull hose off heater pipes. If antifreeze is in use in cooling system, save the solution. After cooling system has drained completely, close engine block and radiator drain valves.

j. **Drain Engine Oil.** Remove oil pan drain plug. After oil has drained, install plug securely. Reinstall hull plate gasket, plate, and screws, applying waterproofing compound to parts to obtain a positive seal.

k. **Remove Bulkhead with Starter Solenoid Switch, Voltage Regulator, Fire Extinguisher, Rear Demolition Bomb Case, and Demolition Timer Control Switch.** Remove wires and cable from starter solenoid switch after taking off terminal nuts. Remove wires from terminals on current and voltage regulator and external filter. Bend down clip on offset at rear of bulkhead to unfasten primer lines from bulkhead. Remove screw and nut which retain oil pipe and choke tube clip to bulkhead. Take out cap screws holding left and right sides of bulkhead to bulkhead frame. Remove metal screw and clip to free demolition wires from front of bulkhead. Turn and pull out plug from bottom of demolition timer control switch box and remove wire running through bulkhead from plug. Remove nut, lock washer, and flat washer; pull wiring harness clip off bolt to unfasten harness from rear of bulkhead. Push loose demolition wire through hole in bulkhead. Lift out bulkhead with starter solenoid switch, voltage regulator, fire extinguisher, and demolition equipment (fig. 5).

REMOVAL

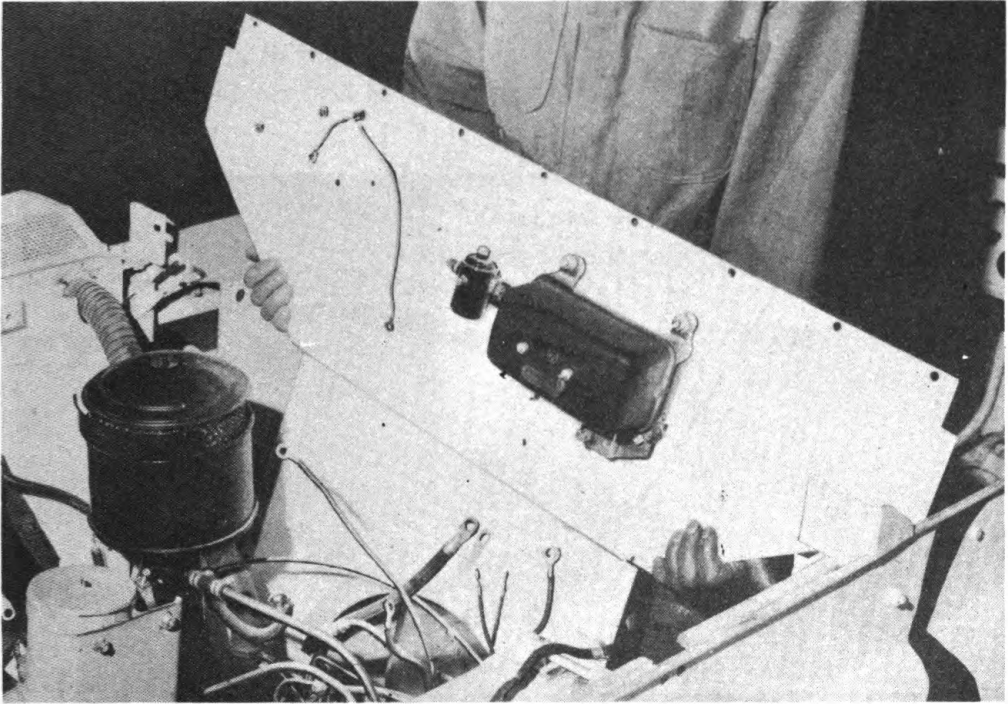

RA PD 49407

Figure 5—Removing Engine Bulkhead

l. Remove Rear Air Duct, Fan Blades and Pulley, and Radiator with Fan Shroud. Lift off rear air duct with lid and sponge rubber gasket after removing cap screws, lock washers, and flat washers which secure air duct to rear of hull. Loosen generator hinge bolts, adjusting arm pivot screw, and move generator toward engine to relieve fan belt tension. Remove cap screws holding fan blades and pulley to water pump drive flange. Lift blades and pulley off belt, and out from within fan shroud, and off vehicle. Loosen radiator inlet upper base clamp and upper outlet hose clamp and pull off hose. Pull off cylinder block drain hose at the drain valve in radiator outlet pipe. Remove six metal screws holding left and right radiator flanges to radiator frame of hull. Lift radiator and shroud upward to clear water pump drive flange and tilt top of the assembly in such a manner as to permit radiator outlet pipe and drain valve to clear.

m. Disconnect Engine Ground Strap, Engine Support Bracket Mountings, and Generator Wires. Disconnect engine ground strap from hull by removing bolt, nut, two flat washers, and lock washer. Take out cotter pins and remove two castellated nuts and flat washers from engine support mounting bracket bolts (fig. 6). Disconnect wires from generator terminals.

n. Disconnect Engine Heat Indicator, Oil Pressure Gage, Primer Pipes, Fuel Tank Line, and Ignition Coil. Uncouple heat indicator element at distributor side of cylinder head. Disconnect oil pressure gage pipe

**ORDNANCE MAINTENANCE — ENGINE, ENGINE ACCESSORIES,
AND CLUTCH FOR CARGO CARRIER M28 (T15)**

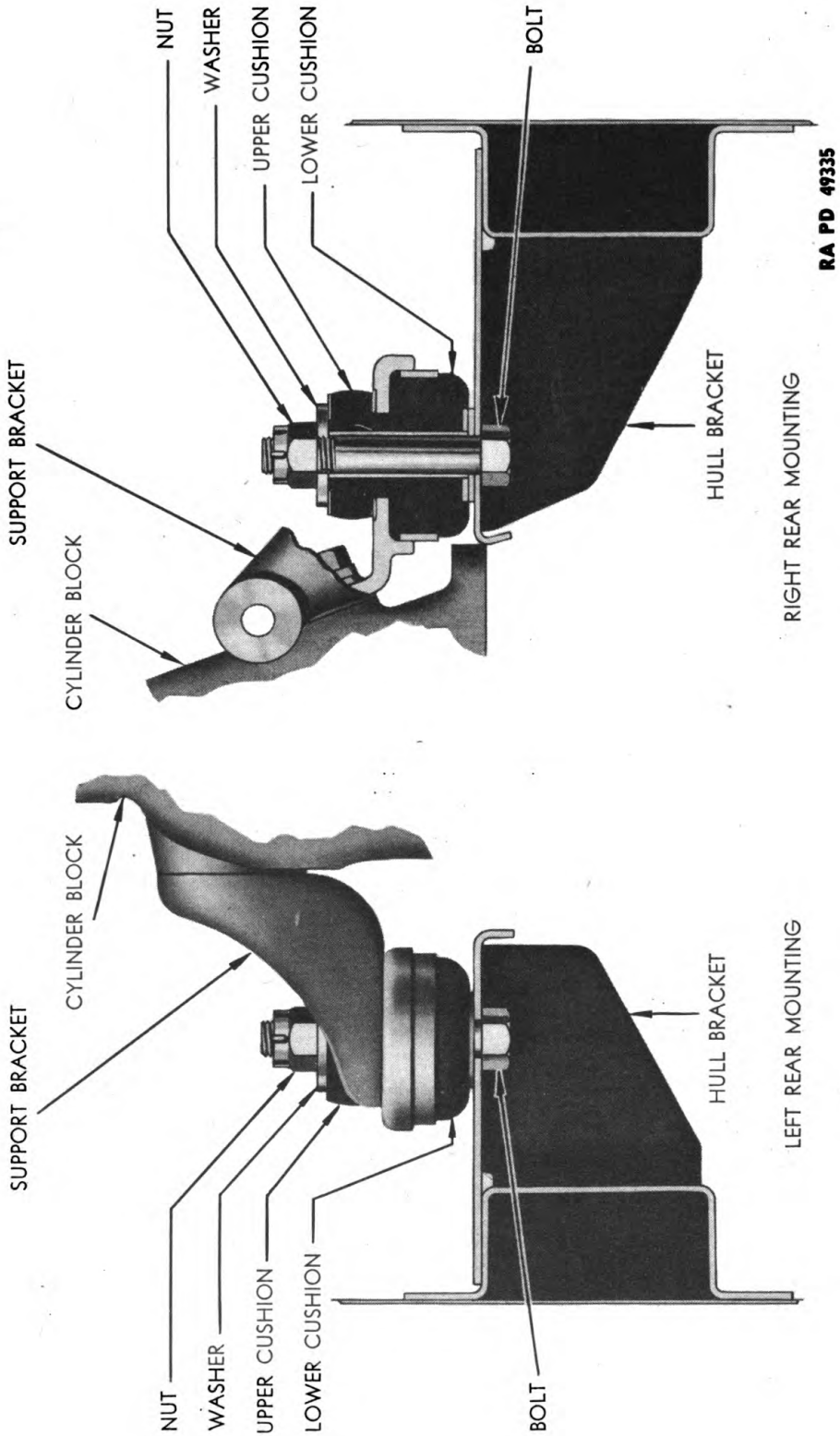
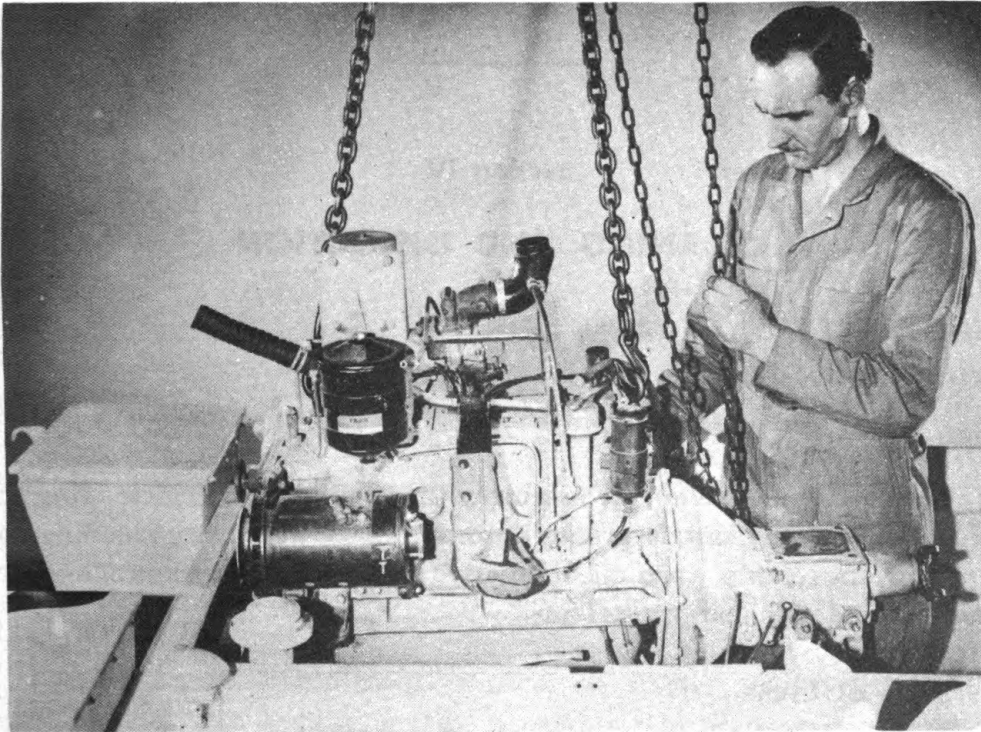

Figure 6—Engine Support Bracket Mounting Construction

REMOVAL

from flexible coupling above No. 6 cylinder of engine. Disconnect primer suction pipe at its flexible coupling above No. 6 cylinder. Disconnect primer pipe running to intake manifold at first T-connection. Disconnect fuel tank pipe at lower end of flexible coupling. Disconnect harness wire from ignition coil.

o. Disconnect Choke and Throttle Controls. Remove screw holding throttle cable tube clip to cylinder head clip. Disconnect carburetor throttle valve control by unhooking pull-back spring and remove clevis pin



RA PD 49402

Figure 7—Removing Engine Using Lifting Eyebolt 41-B-1586-150

and clevis from throttle valve operating arm. Disconnect carburetor choke control after loosening choke valve lever swivel clamp screw and cable clamp screw at fastening bracket.

p. Uncouple Exhaust Pipe. Remove bolt and nut which secure exhaust pipe clamp to support bracket at flywheel end of cylinder head. Spread clamp and pull section with the flexible end upward, and off lower section of exhaust pipe.

q. Disconnect Engine Transmission Support. Remove two cap screws with lock washers which hold engine transmission support to hull frame.

r. Install Lifting Eyes. Remove cylinder head screws No. 9 and No. 10 (see cylinder head cap screw tightening chart—fig. 46). Install

**ORDNANCE MAINTENANCE — ENGINE, ENGINE ACCESSORIES,
AND CLUTCH FOR CARGO CARRIER M28 (T15)**

engine lifting eyebolts (41-B-1586-150) in place of two cylinder head screws removed.

a. **Remove Engine (including Clutch and Transmission).** Attach a chain to lifting eyebolts. Fasten hoist to chain and, after checking to make sure all wires, cables, lines, and connections to hull or other units have been disconnected, slowly lift weight of engine off engine support brackets and hull frame (fig. 7). Move engine forward slightly, then up and out of compartment, guiding it carefully to avoid catching uncoupled pipes, wires, or controls.

Section IV

CLEANING AND INSPECTION

	Paragraph
Cleaning	8
Inspection	9

8. CLEANING.

a. Clean removed engine assembly thoroughly with dry-cleaning solvent. Remove any dirt or grease accumulations, which dry-cleaning solvent will not readily wash off, with a wire brush or putty knife, and dry entire engine with compressed air.

9. INSPECTION.

a. Inspect cylinder block and head for cracks which will be indicated by leakage of cooling solution. Inspect oil pan, timing gear cover, and valve cover plates for cracks or holes which will be indicated by evidence of oil leakage. Inspect oil and fuel lines and connections for leakage of oil or fuel. Inspect fuel pump to block gasket for evidence of oil leaks. Inspect water pump and gasket for evidence of leaks in cooling system. Inspect cylinder head water outlet for evidence of leaks.

CHAPTER 2
ENGINE (Cont'd)

Section V

REMOVAL OF ACCESSORIES

	Paragraph
Transmission.....	10
Starter	11
Clutch	12
Generator.....	13
Ignition coil.....	14
Distributor with wiring.....	15
Water pump.....	16
Fuel pump.....	17
Carburetor	18
Manifold assembly	19
Oil filter assembly and diluter.....	20
Spark plugs.....	21

10. TRANSMISSION.

a. Take out four cap screws and lock washers holding transmission to clutch housing and remove transmission.

11. STARTER.

a. Disconnect cable from terminal on starter. Remove nuts, lock washers, and bolts holding starter to engine rear plate, and pull starter away from plate and engine.

12. CLUTCH.

a. Remove screws, bolts, and nuts holding clutch housing to engine rear plate and remove housing. Take out cap screws holding clutch assembly to flywheel, relieving pressure on cap screws, evenly, to prevent distortion of pressure plate cover, and remove entire clutch assembly.

13. GENERATOR.

a. Lift fan belt out of generator pulley, take out nuts, lock washers, and bolts, and remove generator from engine.

14. IGNITION COIL.

a. Disconnect coil to distributor primary wire and secondary wire from coil. Take out cylinder head screw, that holds coil and bracket to cylinder head, and remove coil.

**ORDNANCE MAINTENANCE — ENGINE, ENGINE ACCESSORIES,
AND CLUTCH FOR CARGO CARRIER M28 (T15)**

15. DISTRIBUTOR WITH WIRING.

a. Disconnect spark plug wires from spark plug terminals. Take out distributor control arm fastening screw and remove distributor with spark plug wires from engine.

16. WATER PUMP.

a. Remove cap screws holding water pump to cylinder block, and remove water pump assembly and gasket.

17. FUEL PUMP.

a. Remove fuel pump to carburetor pipe, primer inlet pipe and coupling, and fuel pump inlet pipe. Take out the two cap screws holding fuel pump to cylinder block and remove pump and gasket.

18. CARBURETOR.

a. Disconnect and remove crankcase ventilator pipe from carburetor air cleaner elbow and oil filler tube. Remove cylinder head cap screw holding air cleaner elbow support. Remove nuts holding carburetor to intake manifold and remove carburetor and gasket.

19. MANIFOLD ASSEMBLY.

a. Disconnect and remove valve cover to intake manifold ventilation pipe. Remove nuts and holding clamps from manifold studs and remove manifold and gasket from cylinder block.

20. OIL FILTER ASSEMBLY AND DILUTER.

a. Disconnect and remove oil filter intake line from filter and crankcase fittings, and outlet pipe from bottom of filter and lower end of oil filler tube. Disconnect and remove diluter inlet and outlet pipes. Remove cylinder head cap screws that anchor filter and diluter bracket to cylinder head, and remove filter and diluter with bracket from engine.

21. SPARK PLUGS.

a. Remove spark plugs with spark plug socket and handle, being careful not to crack porcelain body when removing.

CHAPTER 2
ENGINE (Cont'd)

Section VI

DISASSEMBLY

Disassembly.....	Paragraph 22
------------------	-----------------

22. DISASSEMBLY.

- a. **Remove Flywheel.** Remove bolt nuts and lock washers holding flywheel to crankshaft flange and remove flywheel from crankshaft flange.
- b. **Remove Water Outlet and Thermostat.** Remove two cylinder head cap screws holding water outlet elbow to cylinder head. Remove water outlet, thermostat, metal sleeve, and gaskets.
- c. **Remove Cylinder Head.** Remove all cylinder head cap screws and brackets. When removing cylinder head from cylinder block be careful to avoid damaging valves.
- d. **Remove Valves and Valve Springs.** Take out valve cover screws and remove both valve cover plates. Pull out valve lifter tension springs, compress valve springs with a valve spring compressor, and remove valve spring retainer seats. Remove valves from guides and place in a suitable rack to keep them in proper sequence for installation. Pry or lift valve springs and retainers up, to clear valve lifter screws, and remove from valve spring chamber.
- e. **Remove Crankshaft Pulley.** Unlock and remove crankshaft start-

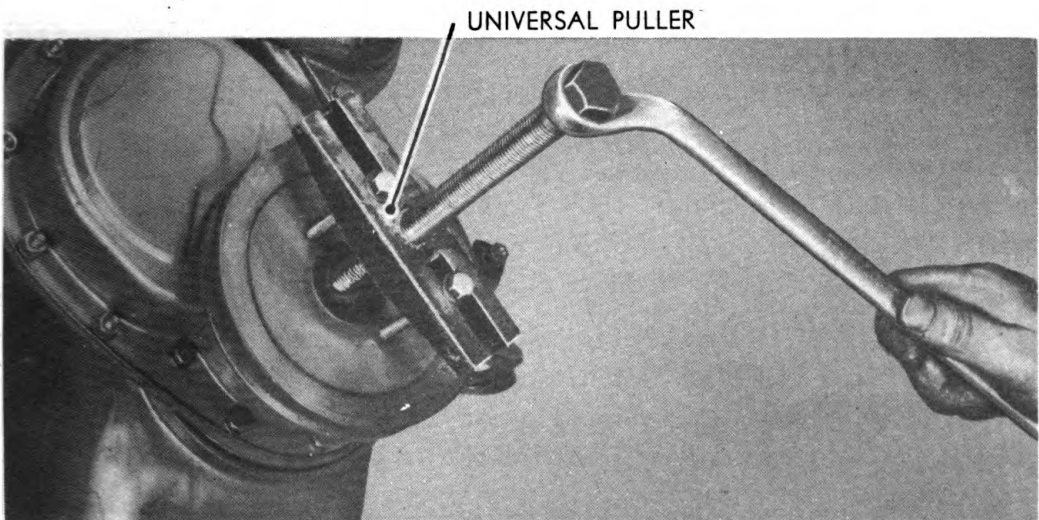

RA PD 309987

Figure 8—Removing Crankshaft Pulley

**ORDNANCE MAINTENANCE — ENGINE, ENGINE ACCESSORIES,
AND CLUTCH FOR CARGO CARRIER M28 (T15)**

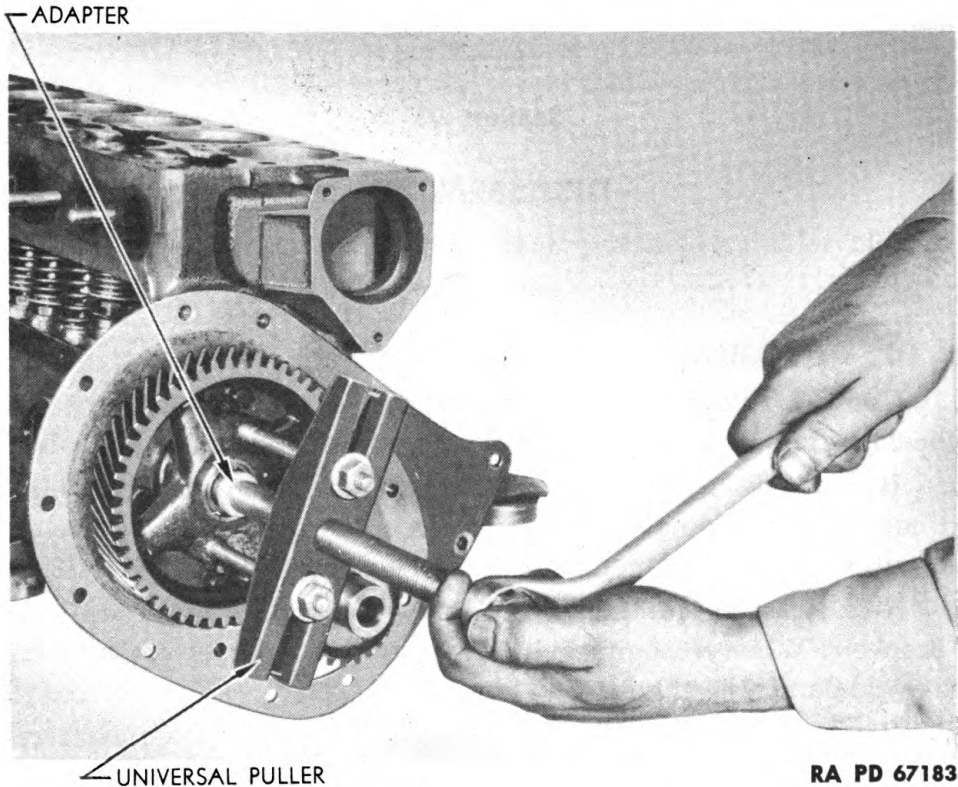

RA PD 67183

Figure 9—Removing Camshaft Gear

ing jaw. Take out screws and remove lock plate. Pull crankshaft pulley with universal puller and plug (fig. 8) and remove Woodruff key from crankshaft.

f. Remove Timing Gear Cover. Take out screws, nuts, and bolts holding cover to engine front plate and remove cover.

g. Remove Timing Gears. Check backlash of timing gears before removing them. If backlash is in excess of 0.003-inch, replace gears when reassembling. Pull crankshaft gear with universal puller and remove Woodruff key from crankshaft. Remove screw, lock washer, and plain washer holding camshaft gear to camshaft. Pull gear from camshaft with universal puller (fig. 9). Remove Woodruff key from camshaft.

h. Remove Oil Pan and Oil Strainer. Take out screws holding oil pan to cylinder block and remove oil pan and gasket (fig. 10). Remove screws holding engine oil strainer support in position and remove support, oil strainer, and gasket from cylinder block. Take out cotter pin and remove strainer from support.

i. Remove Oil Pump. Remove screws holding oil pump to cylinder block, remove pump cover and gasket. Pull both gears out of pump body

DISASSEMBLY

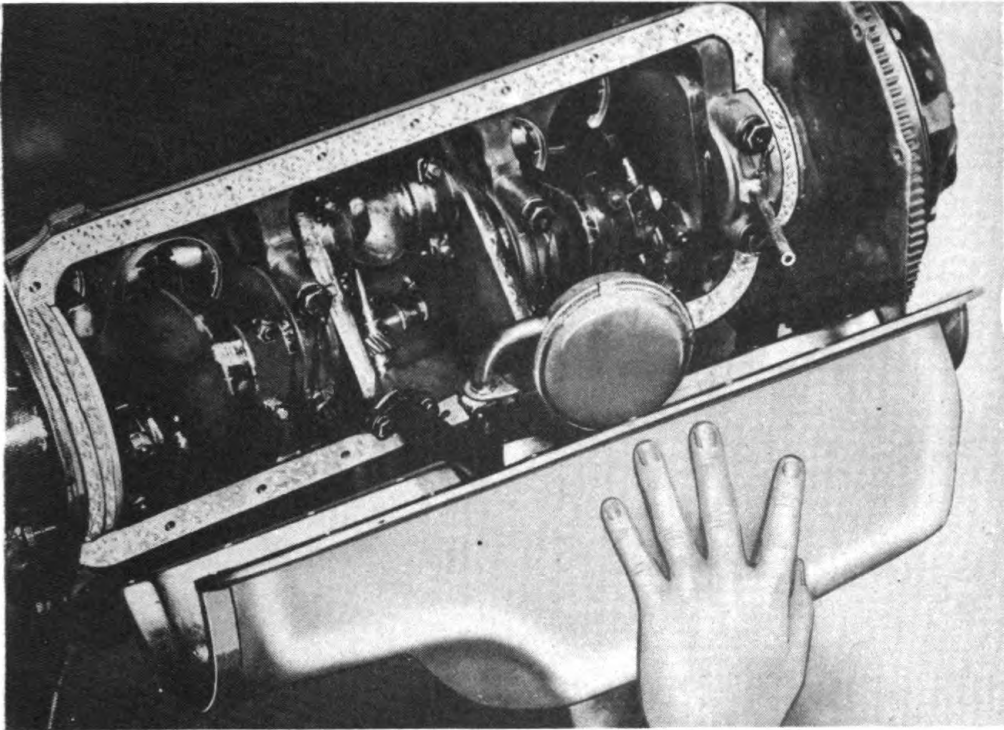

RA PD 66941

Figure 10—Removing Oil Pan

and remove Woodruff key and C washer from pump drive shaft. Remove pump body and gasket from outside of cylinder block, and pump drive shaft from inside of cylinder block.

j. Remove Camshaft and Valve Lifters. Take out screws holding camshaft thrust plate to cylinder block and remove plate and spacer. (If the camshaft is to be removed with valves and springs in position, use valve lifter holders (fig. 11) to raise lifters sufficiently to permit removal of camshaft.) Place the cylinder block in an inverted position, push valve

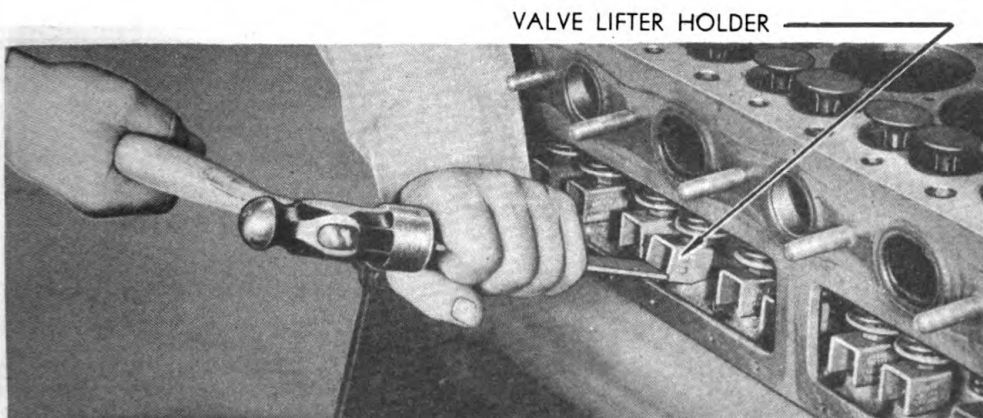

RA PD 67167

Figure 11—Installing Valve Lifter Holder

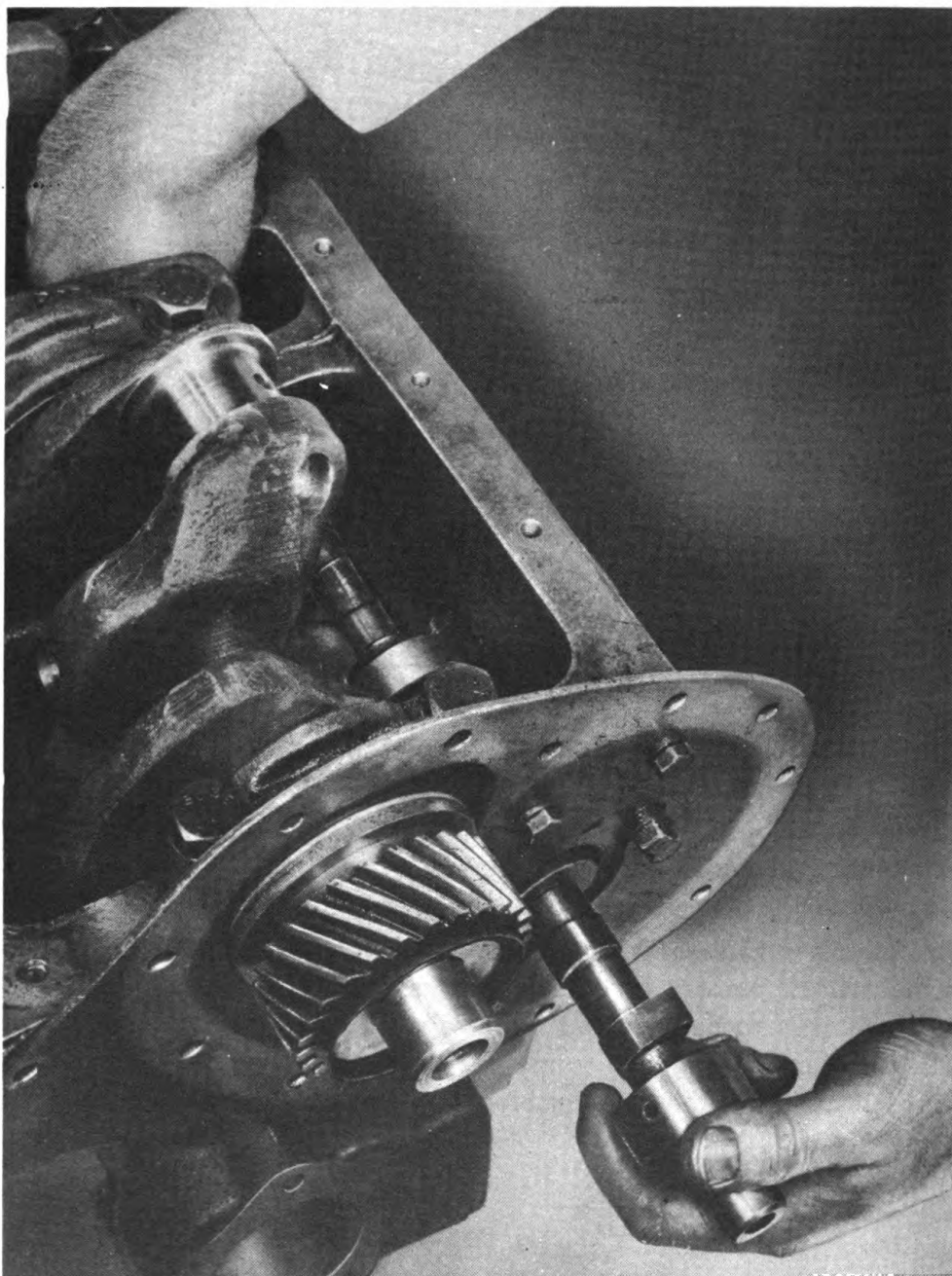
**ORDNANCE MAINTENANCE — ENGINE, ENGINE ACCESSORIES,
AND CLUTCH FOR CARGO CARRIER M28 (T15)**

RA PD 66948

Figure 12—Removing Camshaft

lifters away from camshaft lobes, and carefully remove camshaft from cylinder block (fig. 12). Pull valve lifters out of guides in cylinder block and place in a rack to retain proper sequence for installation in the same guides.

k. Remove Connecting Rods and Pistons. Place cylinder block in vertical position; remove palnuts and connecting rod bolt nuts. Care-

DISASSEMBLY

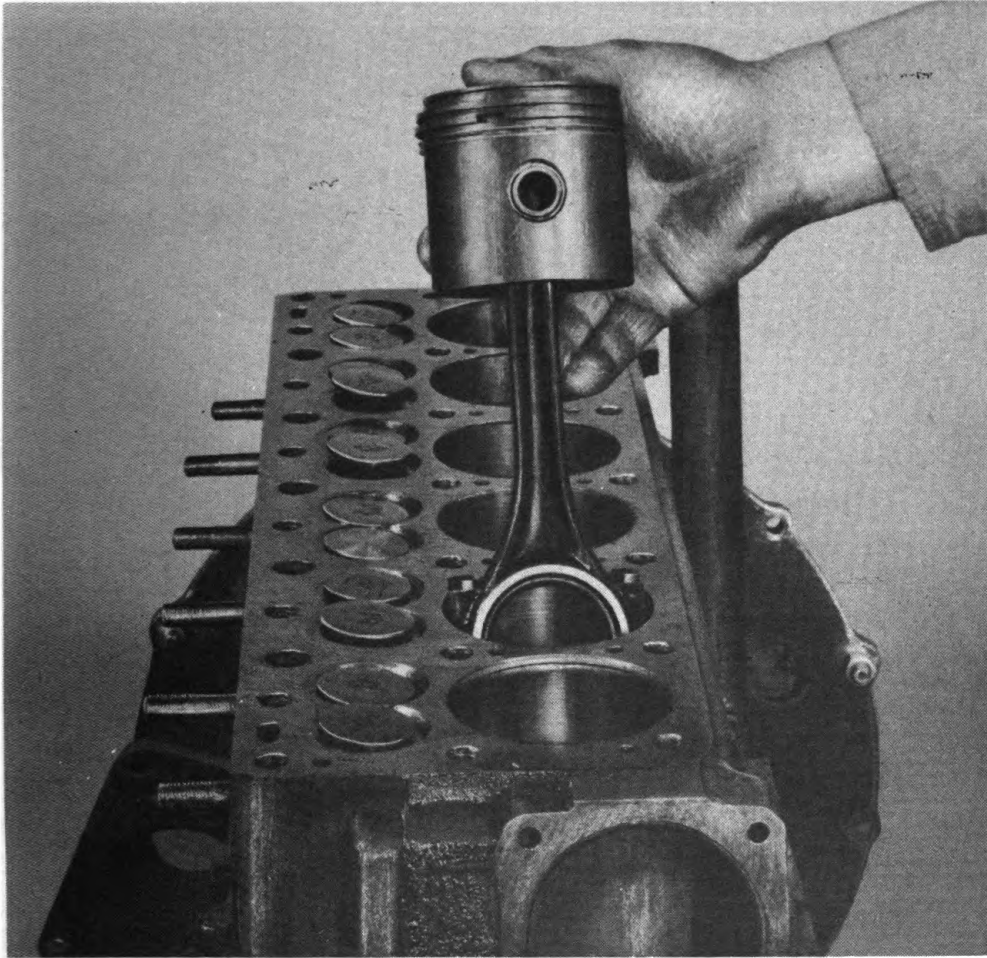

RA PD 66950

Figure 13—Removing Connecting Rod and Piston Assembly

fully remove connecting rod cap from each connecting rod and push connecting rod and piston out through top of cylinder bore (fig. 13). Remove piston rings from each piston with a suitable piston ring tool, being careful to avoid damaging ring grooves in piston. To remove pistons from connecting rods, fasten piston pin replacer (41-R-2395-100) in a vise. Remove nut from shaft, slide piston pin over end of shaft, reinstall nut and tighten. Remove lock nut from tapered pin that retains piston pin in connecting rod, install nut on other end of tapered pin, and tighten sufficiently to loosen pin in connecting rod. While rocking connecting rod, with one hand, pull tapered pin out of connecting rod, remove nut from piston shaft, slide connecting rod and piston assembly off end of tool (fig. 14). Push piston pin out of piston and connecting rod.

1. Remove Engine Front and Rear Plates. Take out cap screws holding front plate to cylinder block and remove plate and gasket. Remove

**ORDNANCE MAINTENANCE — ENGINE, ENGINE ACCESSORIES,
AND CLUTCH FOR CARGO CARRIER M28 (T15)**

PISTON PIN REPLACER 41-R-2395-100

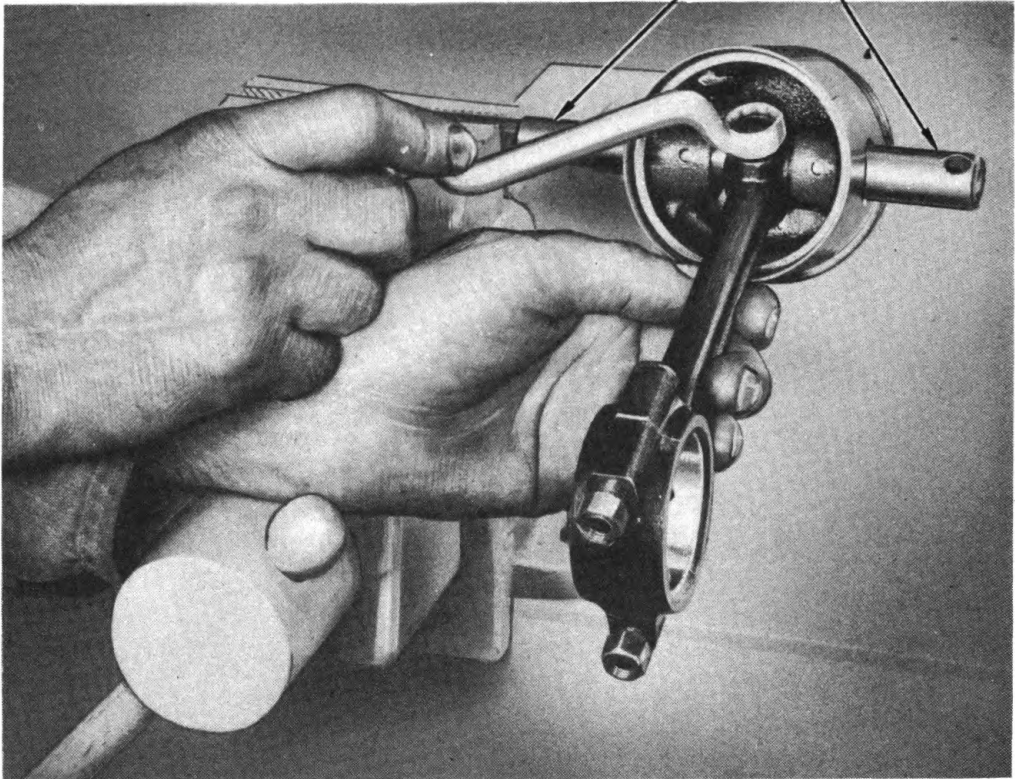

RA PD 67003

Figure 14—Removing Piston Pin

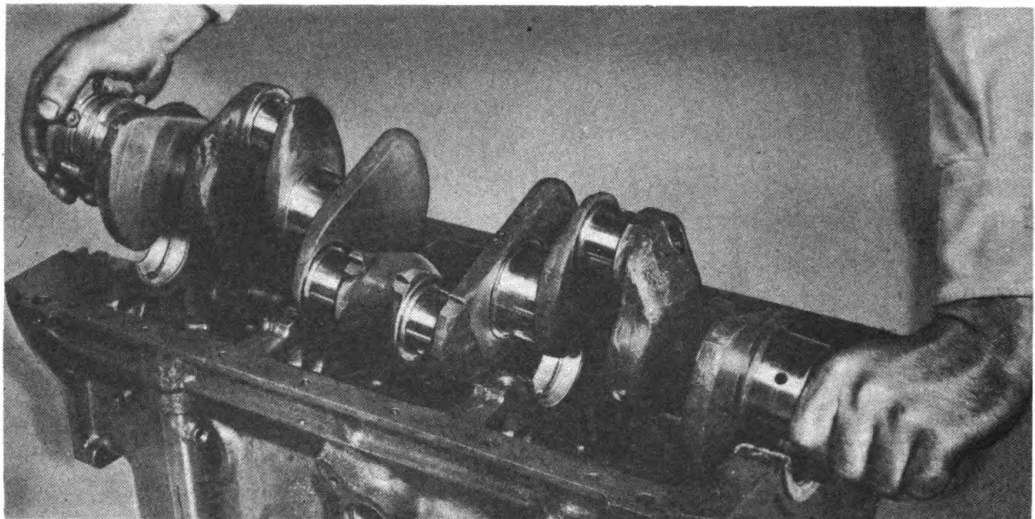

RA PD 66944

Figure 15—Removing Crankshaft

cap screws holding rear plate to cylinder block and pull plate away from block.

m. Remove Crankshaft. Remove locking wire from crankshaft main bearing cap screws, take out screws, and remove main bearing caps with

DISASSEMBLY

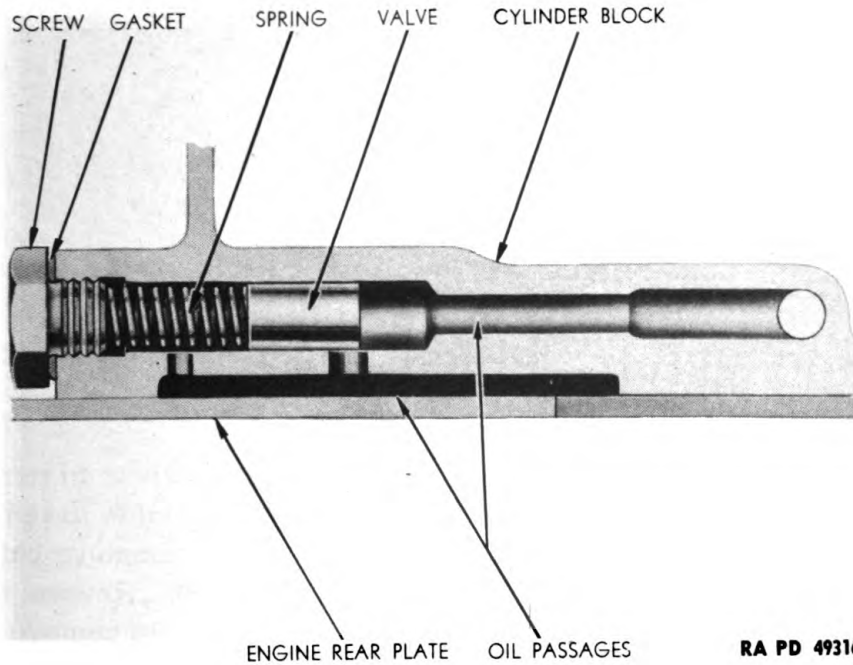

Figure 16—Oil Pressure Relief Valve Construction

lower half of main bearing shells from cylinder block. Lift crankshaft out of cylinder block (fig. 15), being careful to avoid damaging journals. Remove main bearing shells from main bearing caps and cylinder block.

n. Remove Engine Support Brackets. Take out cap screws that hold support brackets in position and remove from cylinder block.

o. Remove Oil Pressure Relief Valve. Remove plug and gasket that retains the oil pressure relief valve in manifold side of cylinder block just below engine support bracket pad. Pull spring and valve (fig. 16) out of passage for cleaning and inspection.

ORDNANCE MAINTENANCE — ENGINE, ENGINE ACCESSORIES,
AND CLUTCH FOR CARGO CARRIER M28 (T15)

CHAPTER 2

ENGINE (Cont'd)

Section VII

CLEANING OF ENGINE PARTS

Cleaning.....	Paragraph 23
---------------	--------------

23. CLEANING.

a. Clean all engine parts carefully in dry-cleaning solvent to remove all grease, dirt, gaskets, and foreign matter. Use a putty knife to remove any gaskets or sealer remaining on machined surfaces. Remove carbon formation from valves and valve guides with a wire brush. Reverse flush the water passages in cylinder head and cylinder block to remove any loose sediment or rust. Clean all carbon formation from cylinder head and

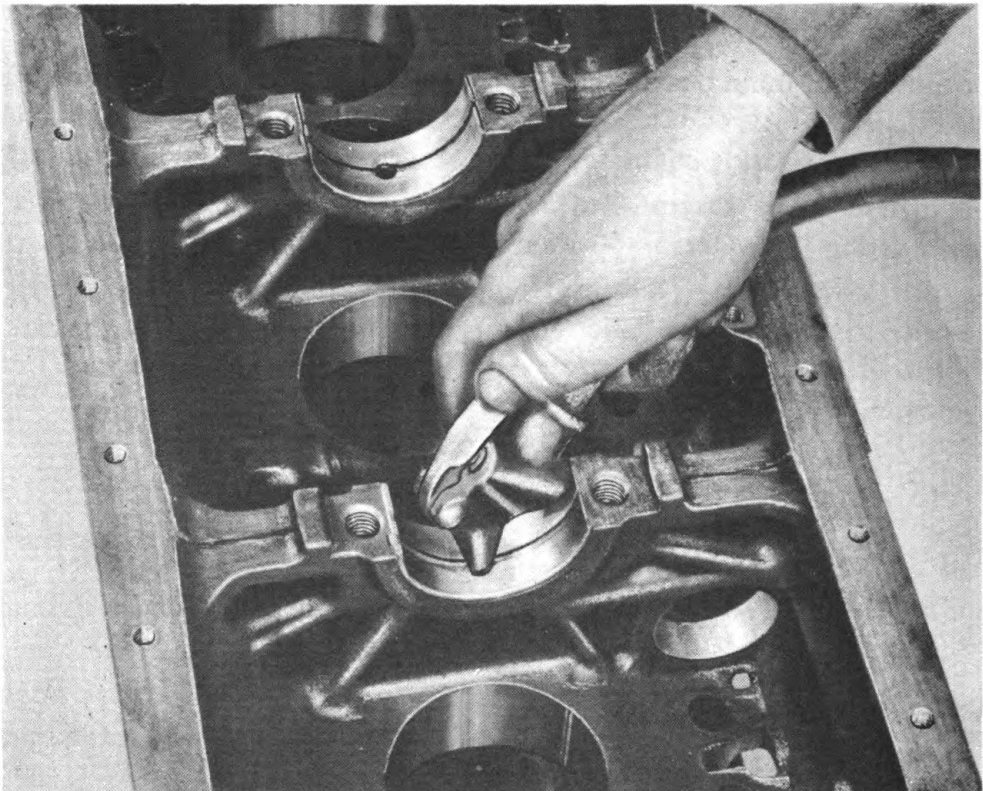

RA PD 309750

Figure 17—Cleaning Oil Passages in Crankcase Webs

CLEANING OF ENGINE PARTS

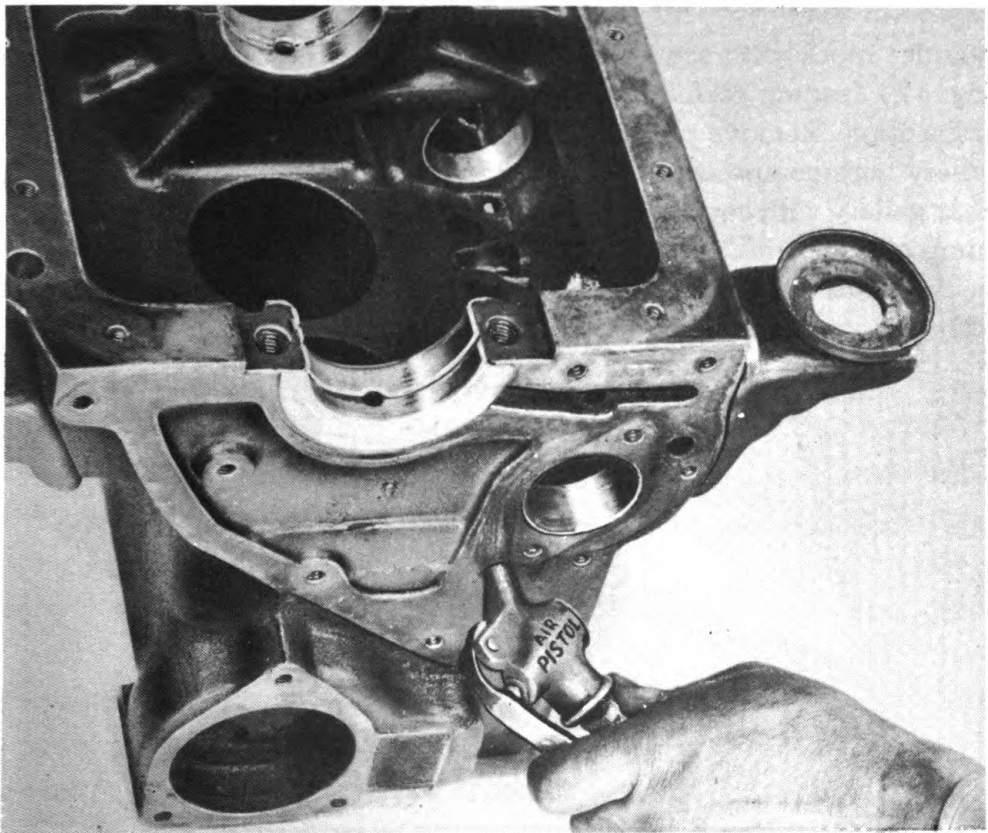

RA PD 67011

Figure 18—Cleaning Main Oil Gallery

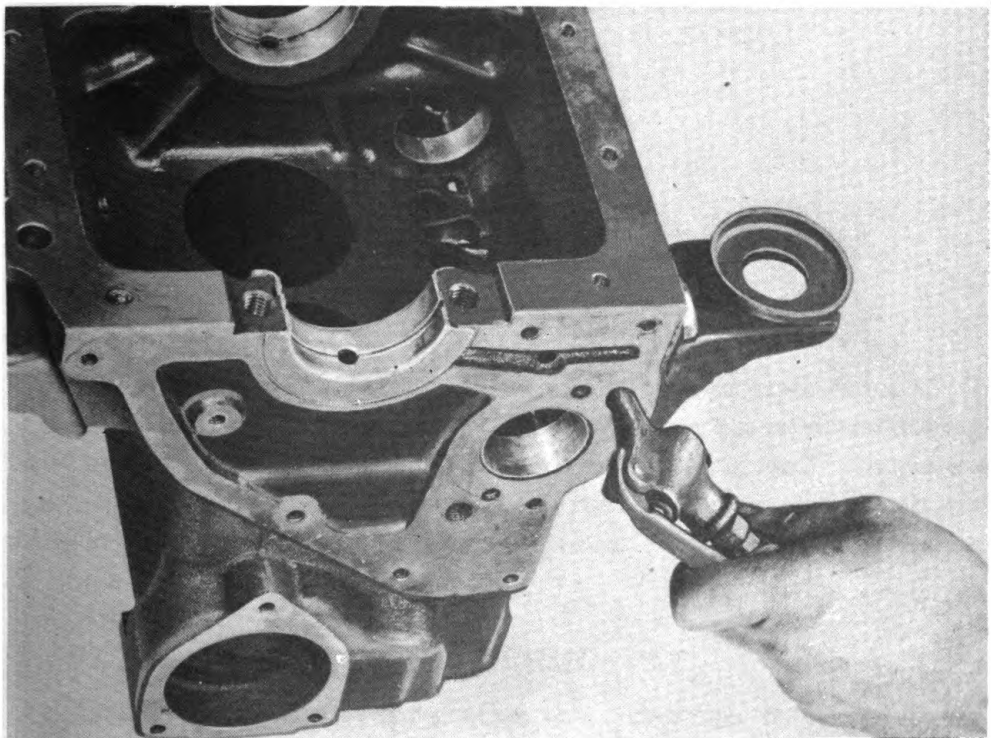

RA PD 67010

Figure 19—Cleaning Oil Pump and Valve Lifter Oil Gallery

**ORDNANCE MAINTENANCE — ENGINE, ENGINE ACCESSORIES,
AND CLUTCH FOR CARGO CARRIER M28 (T15)**

cylinder block with a wire brush. Clean oil passages in crankcase webs (fig. 17) leading to main oil gallery and camshaft bearings with compressed air. Remove plugs from both ends of main oil gallery and clean gallery with compressed air (fig. 18). Blow through oil pump and valve lifter gallery with compressed air while alternately opening and closing oil pump passage with finger (fig. 19). Also make sure that oil pressure relief passages are clean. Clean oil passages in crankshaft and connecting rods with compressed air.

CHAPTER 2
ENGINE (Cont'd)

Section VIII

INSPECTION OF ENGINE PARTS

	Paragraph
Flywheel	24
Water outlet and thermostat	25
Cylinder head	26
Valves and valve springs	27
Crankshaft pulley and starting jaw	28
Timing gear cover	29
Timing gears	30
Oil pan	31
Oil strainer	32
Oil pump parts	33
Camshaft	34
Valve lifters	35
Connecting rods	36
Pistons and rings	37
Engine front and rear plates	38
Crankshaft	39
Engine support bracket mountings	40
Oil pressure relief valve	41
Cylinder block	42

24. FLYWHEEL.

a. Inspect flywheel for cracked and excessively worn or chipped ring gear teeth. Also examine clutch pilot bushing for scores or other damage. If flywheel is cracked, replace it. Replace ring gear if teeth are worn or chipped so that they are not suitable for further service. If clutch pilot bushing is scored or damaged, replace it, pressing original bushing out and installing a new one with a suitable tool.

25. WATER OUTLET AND THERMOSTAT.

a. Inspect water outlet for cracks, other damage, or sand holes. If damaged, replace with new part. Test water thermostat by immersing it in water heated to rated opening temperature (174°F) of valve. Replace

**ORDNANCE MAINTENANCE — ENGINE, ENGINE ACCESSORIES,
AND CLUTCH FOR CARGO CARRIER M28 (T15)**

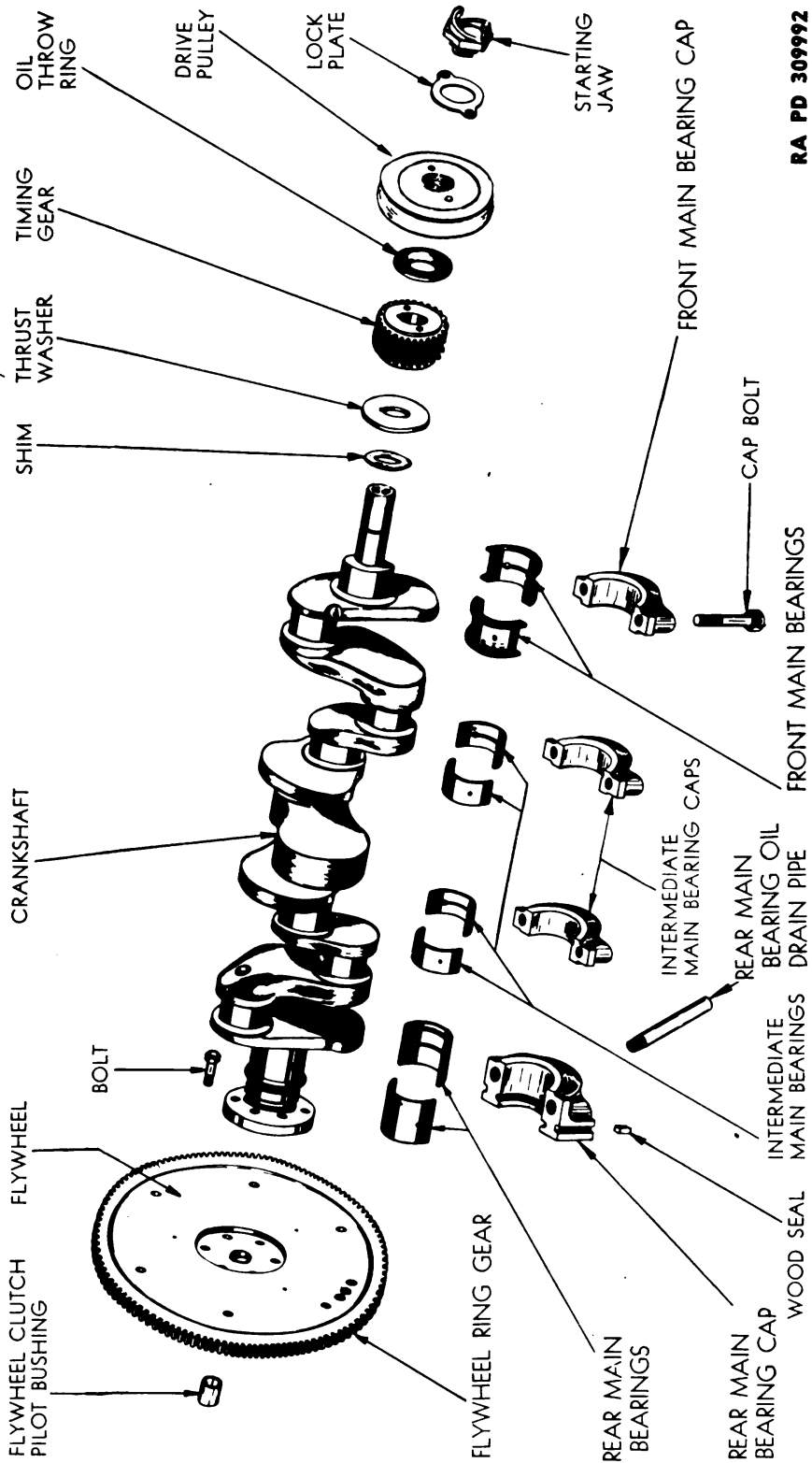

RA PD 309992

Figure 20—Crankcase, Gear, Main Bearings, Pulley, and Flywheel

INSPECTION OF ENGINE PARTS

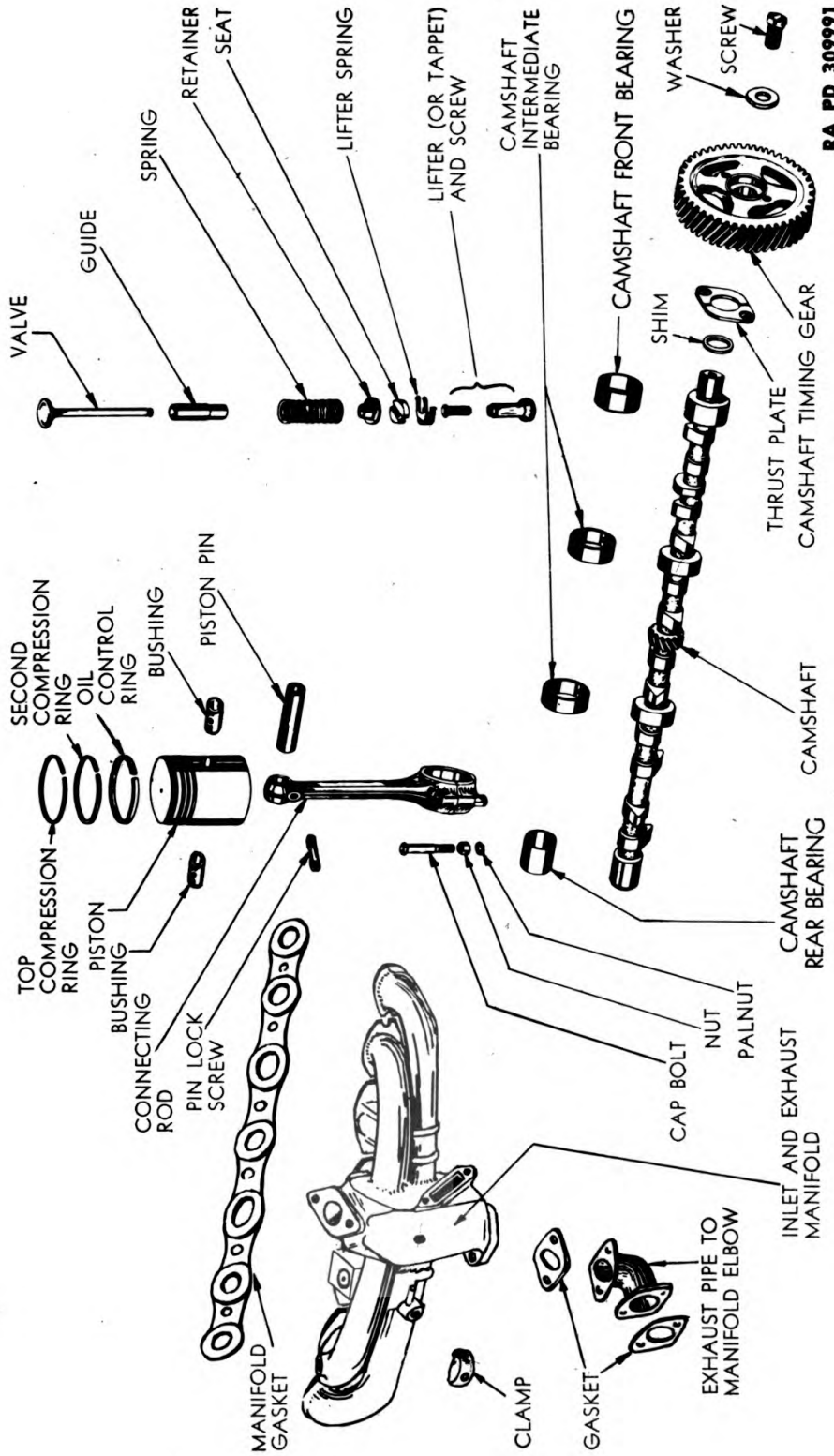

RA PD 309971

Figure 21—Manifold, Camshaft and Gear, Piston and Connecting Rod, and Valve Mechanism Parts

ORDNANCE MAINTENANCE — ENGINE, ENGINE ACCESSORIES,
AND CLUTCH FOR CARGO CARRIER M28 (T15)

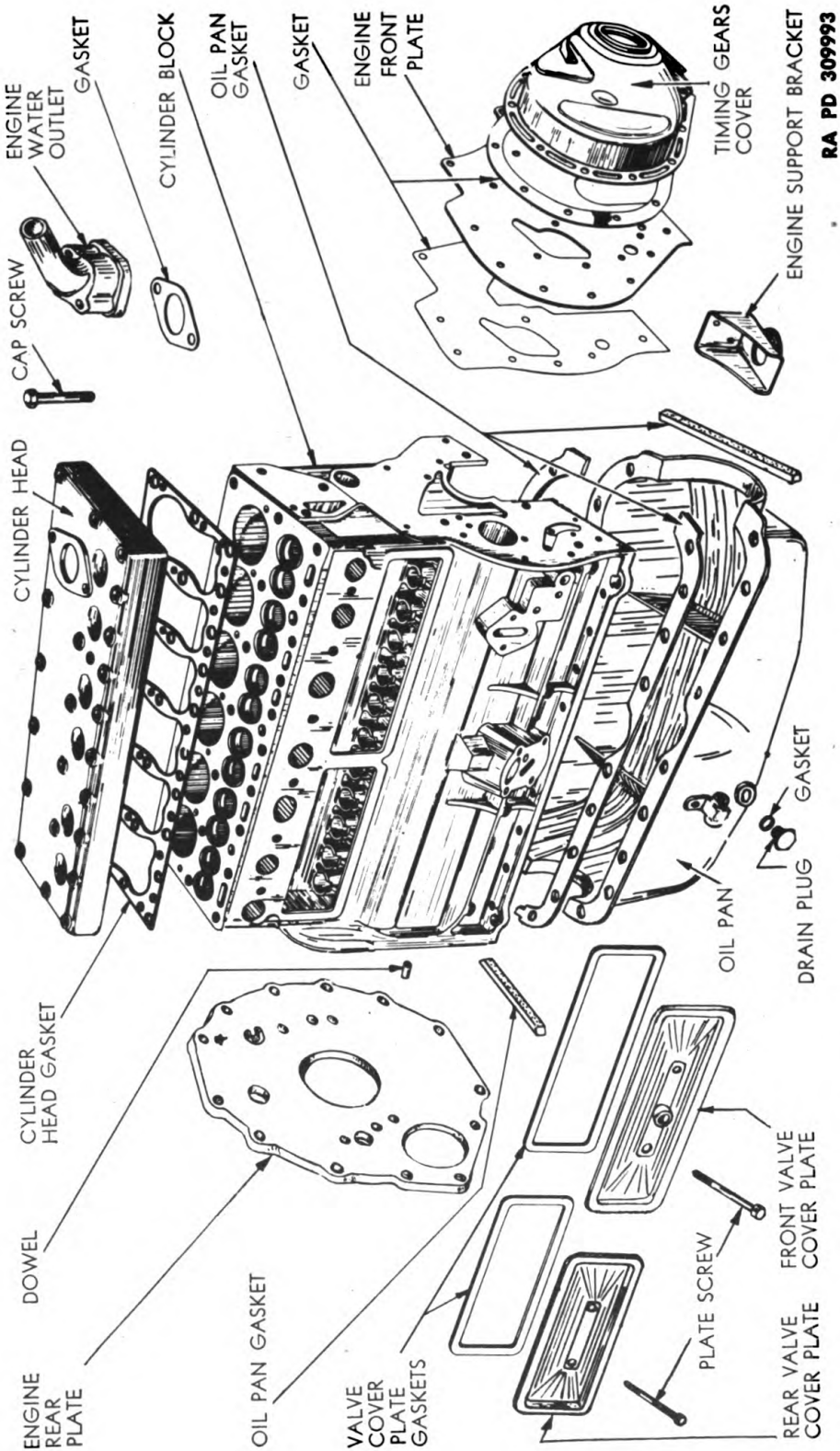
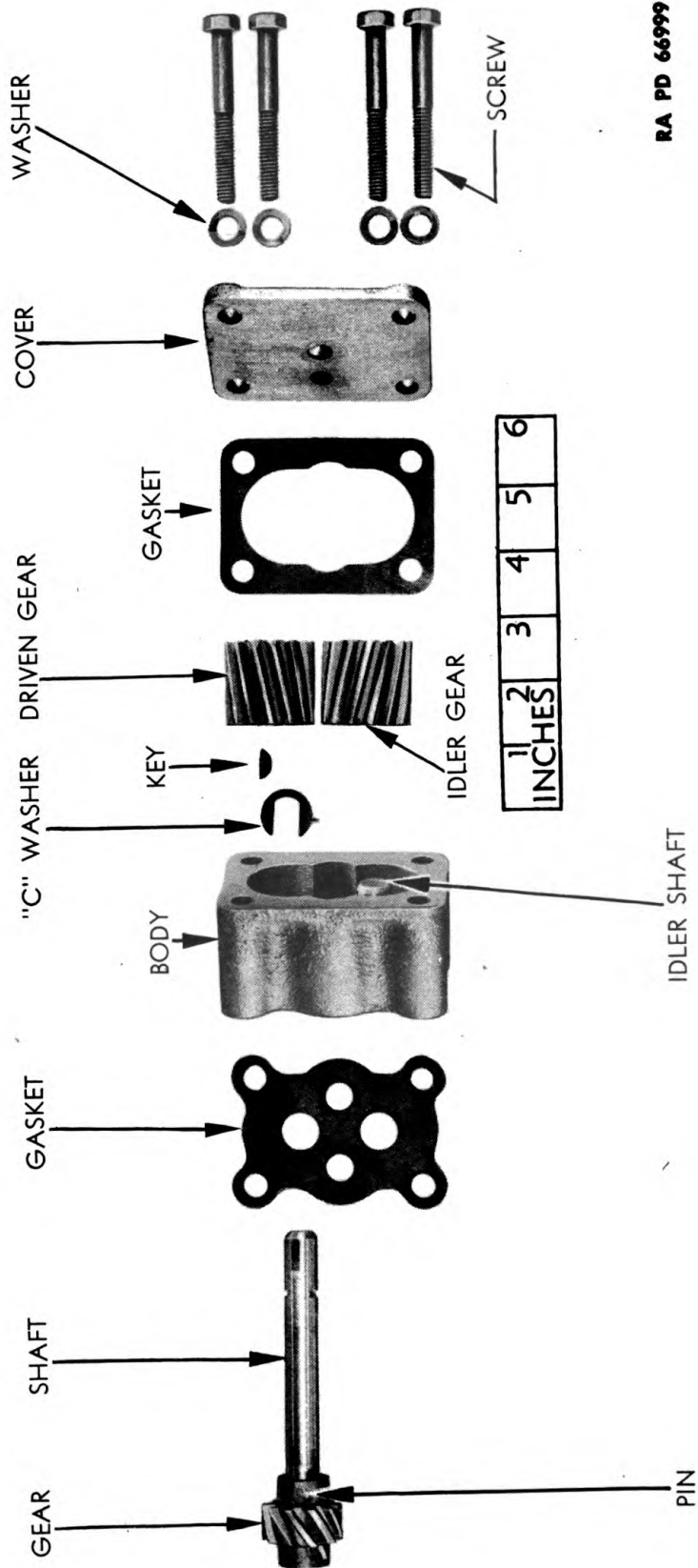

Figure 22—Cylinder Block, Head, Oil Pan, and Parts

INSPECTION OF ENGINE PARTS



RA PD 66999

Figure 23—Oil Pump Parts

**ORDNANCE MAINTENANCE — ENGINE, ENGINE ACCESSORIES,
AND CLUTCH FOR CARGO CARRIER M28 (T15)**

TAPPET WRENCH

SPRING SCALE

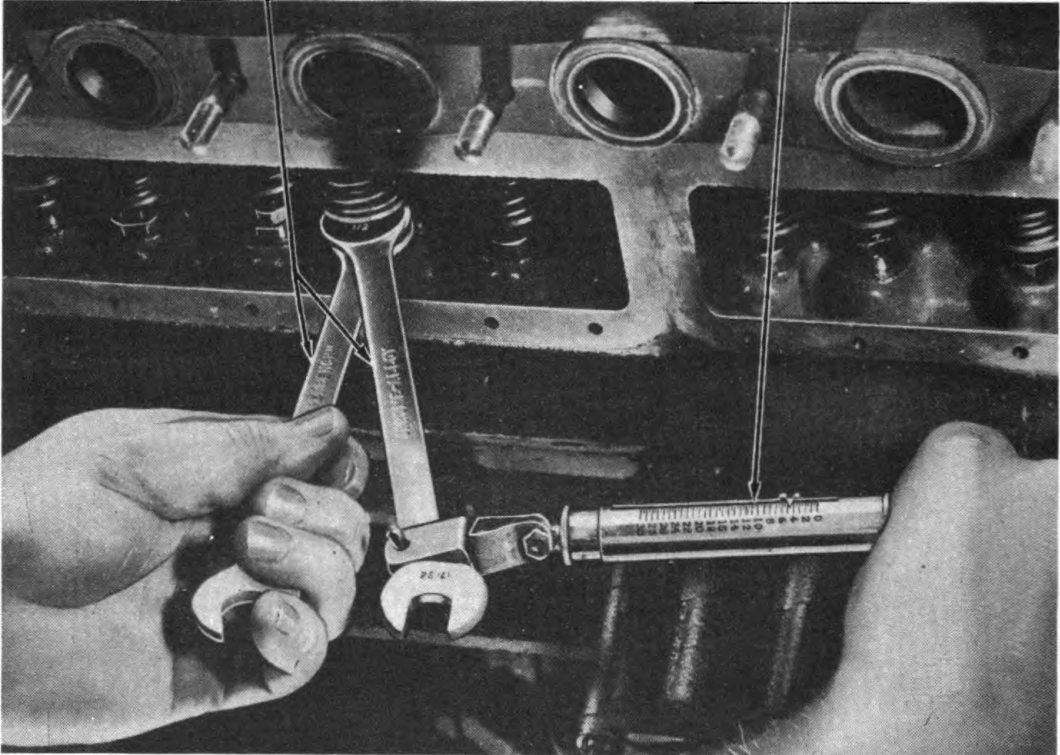

RA PD 66940

Figure 24—Checking Valve Lifter Adjusting Screw Tension

thermostat if it does not start to open at a temperature of 174°F or if it sticks in fully open position.

26. CYLINDER HEAD.

a. Inspect cylinder head for cracks, distortion of more than $\frac{1}{64}$ -inch, stripped threads in spark plug holes, or other damage. Examine cylinder head cap screws for stripped or damaged threads. If cylinder head or cap screws are unfit for further service, replace them.

27. VALVES AND VALVE SPRINGS.

a. Inspect valves for burned, cracked, or warped heads, and stem end for scored surfaces where they contact valve lifter adjusting screw face. If not satisfactory for further service, recondition or replace them. Compress valve springs with a suitable tester to a length of $1\frac{7}{16}$ inches. Satisfactory springs will require from 77 to 85 pounds pressure to compress. Replace springs that do not have proper tension.

28. CRANKSHAFT PULLEY AND STARTING JAW.

a. Inspect crankshaft pulley for bent or damaged flanges, a cracked hub, or damaged keyway, and replace if not satisfactory for further service.

INSPECTION OF ENGINE PARTS

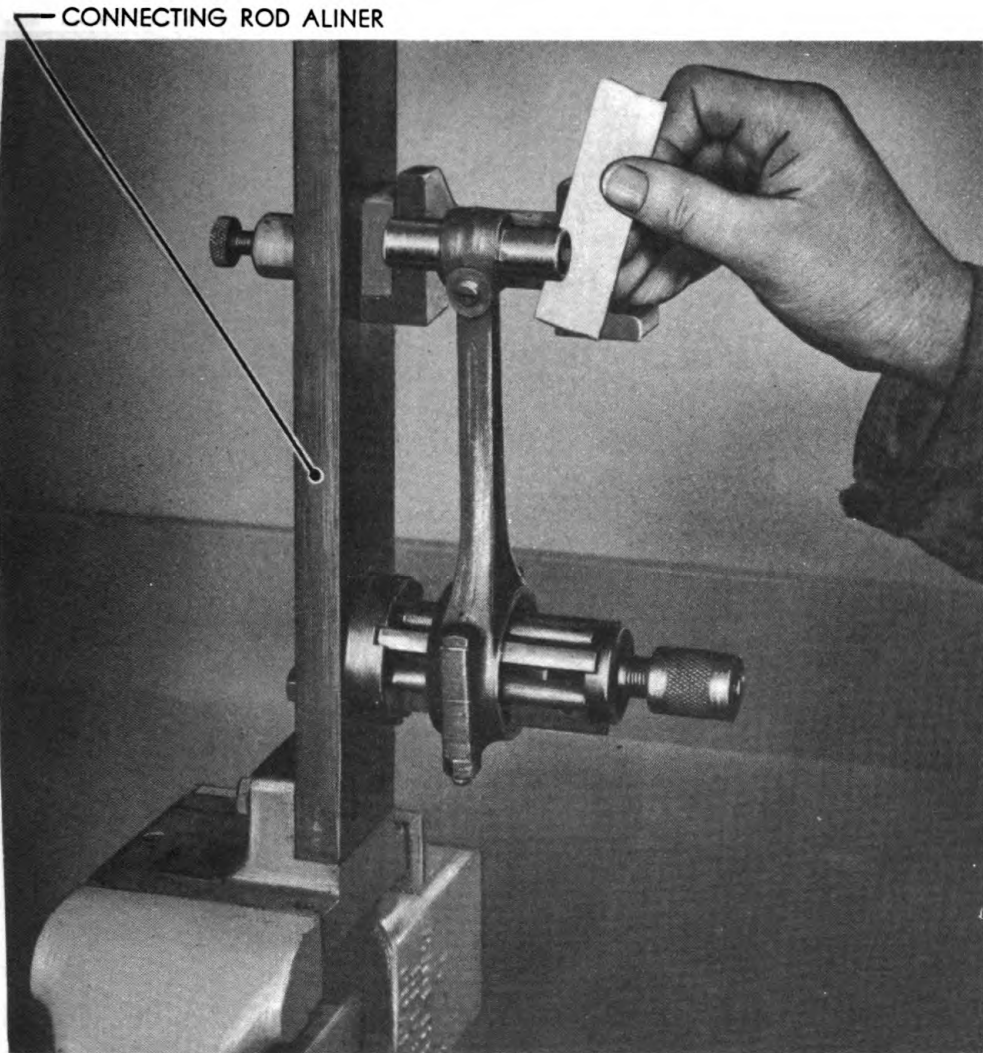

RA PD 66989

Figure 25—Checking Connecting Rod for Twist, Using Universal Connecting Rod Aliner 41-A-135

Examine starting jaw for damaged threads or breakage and replace if not fit for further service.

29. TIMING GEAR COVER.

a. Inspect timing gear cover for distortion, cracks, or breaks, and oil seal for damage. If distorted, cracked, or broken, replace it. If cover oil seal is damaged, replace seal.

30. TIMING GEARS.

a. Inspect timing gears for cracks or damaged teeth. Examine keyways in both gears for damage. Replace gears if found to be unfit for further service.

**ORDNANCE MAINTENANCE — ENGINE, ENGINE ACCESSORIES,
AND CLUTCH FOR CARGO CARRIER M28 (T15)**

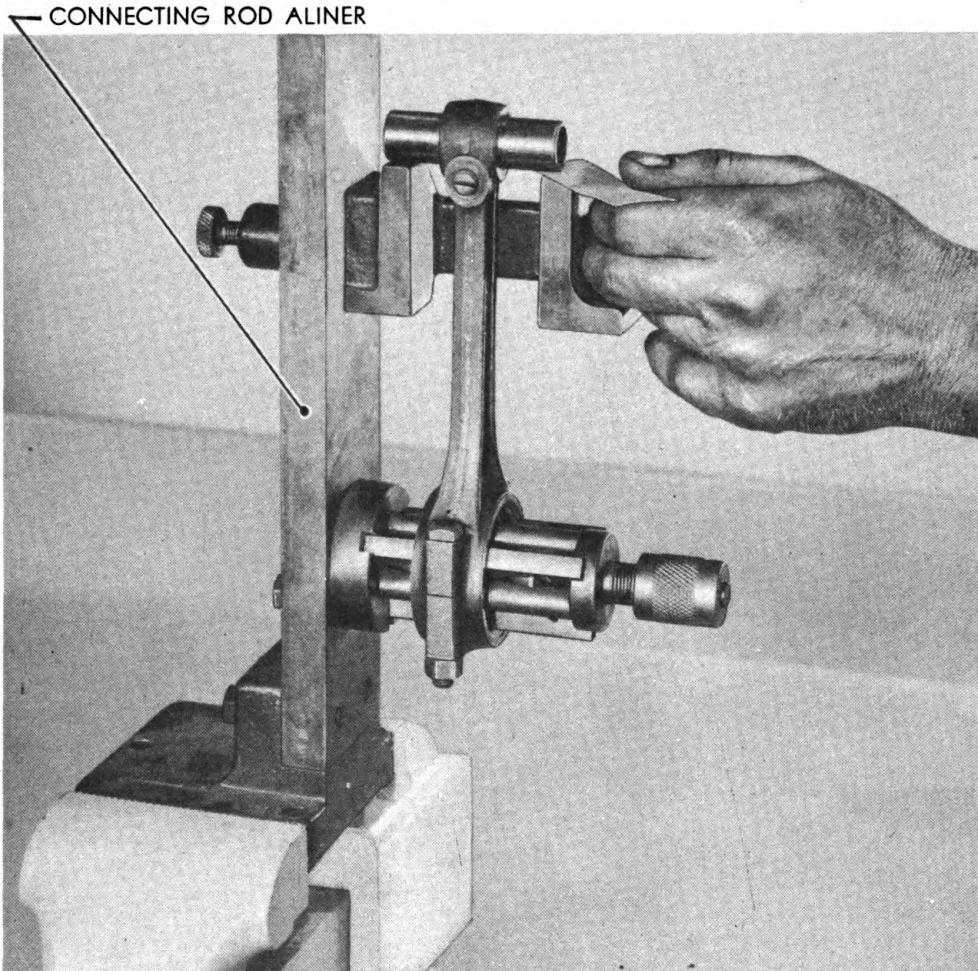

RA PD 66988

**Figure 26—Checking Connecting Rod for Bent Condition, Using
Universal Connecting Rod Aliner 41-A-135**

31. OIL PAN.

a. Inspect oil pan for loose baffle plates, drain plug reinforcing plate, and stripped or damaged plug threads as well as for dents, cracks, and distortion. Replace oil pan if it cannot be placed in a serviceable condition by repairs and welding.

32. OIL STRAINER.

a. Examine oil strainer for breaks in screen and leaks in suction pipe or float. Inspect stops on lower end of suction pipe to make sure they are not bent out of position. If oil strainer cannot be placed in a serviceable condition, replace it.

INSPECTION OF ENGINE PARTS

CONNECTING ROD ALINER

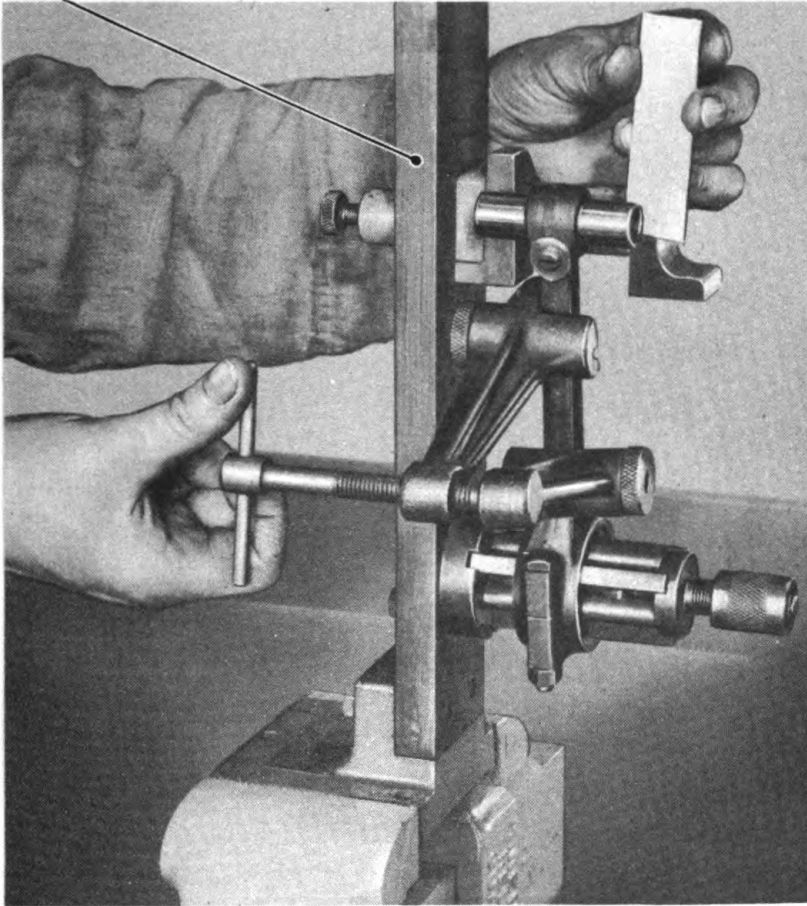

RA PD 66951

Figure 27—Alining Connecting Rod to Eliminate Twist, Using Universal Connecting Rod Aliner 41-A-135

33. OIL PUMP PARTS (fig. 23).

a. Inspect oil pump body and cover for cracks, distortion, or other damage. Examine oil pump retaining screws for stripped or damaged threads. Inspect oil pump gears for chipped or damaged teeth and keyway in drive gear for damage. Examine oil pump drive shaft and gear for scores or damage and keyway in shaft for damage. Replace any parts found to be unfit for further service.

34. CAMSHAFT.

a. Inspect camshaft for scored or damaged journals or cam lobes and replace if unfit for further service. Place camshaft in V-blocks and check alinement. If misalinement exceeds 0.006 inch, replace camshaft.

35. VALVE LIFTERS.

a. Inspect valve lifters for cracked or chipped condition on lower surface that contacts camshaft lobe. Test valve lifter screw for proper

ORDNANCE MAINTENANCE — ENGINE, ENGINE ACCESSORIES,
AND CLUTCH FOR CARGO CARRIER M28 (T15)

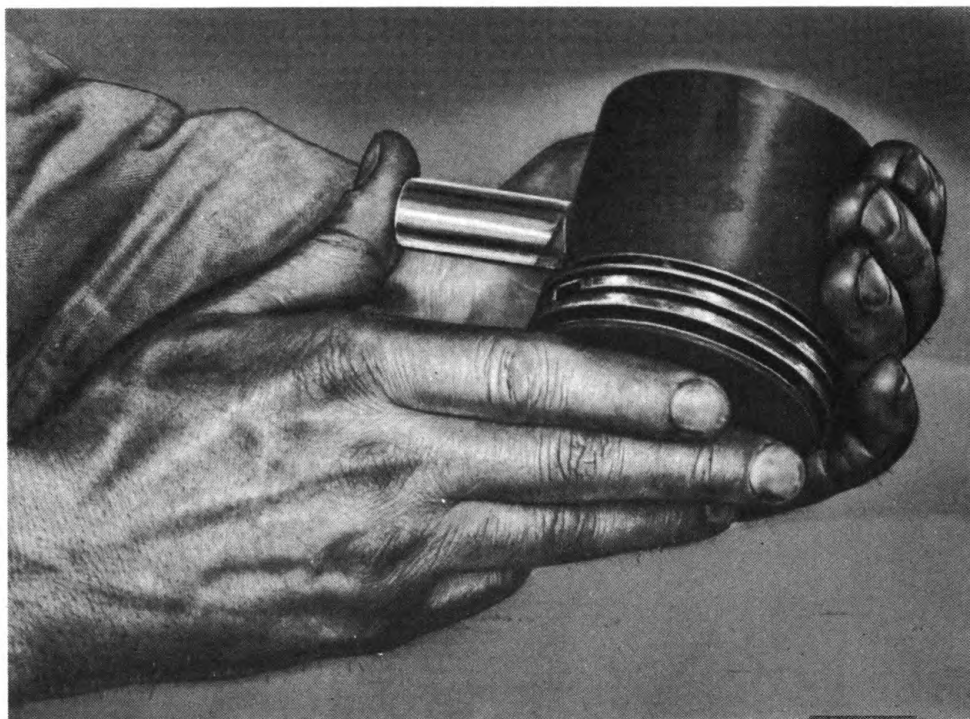

RA PD 66962

Figure 28—Fitting Piston Pin

tension required to turn screw in lifter. A force of at least 25 inch-pounds (4-lb pull with a spring scale attached to 6-in. tappet wrench) is required (fig. 24). Inspect for a chipped condition on surface that contacts end of valve stem. Replace parts that are unfit for further service.

36. CONNECTING RODS.

a. Inspect connecting rods for scored or burned bearing surfaces, alignment (figs. 25 and 26), crank pin journal clearance, and end play. Align connecting rods if they are twisted (fig. 27) and replace them if bent. The connecting rod bearing to crank pin journal clearance is from 0.0005 inch to 0.002 inch and if clearance is greater, replace rod. Replace connecting rods if end play is greater than 0.009 inch. If connecting rod bearing surfaces are burned or scored, replace connecting rod.

37. PISTONS AND RINGS.

a. Inspect pistons for scores, carbon formation in ring grooves, or other damage. Examine piston pins for scores and proper fit in pistons. The proper piston pin fit is obtained when pin will just slide through the ore in piston of its own weight (fig. 28). Clean any carbon formation

INSPECTION OF ENGINE PARTS

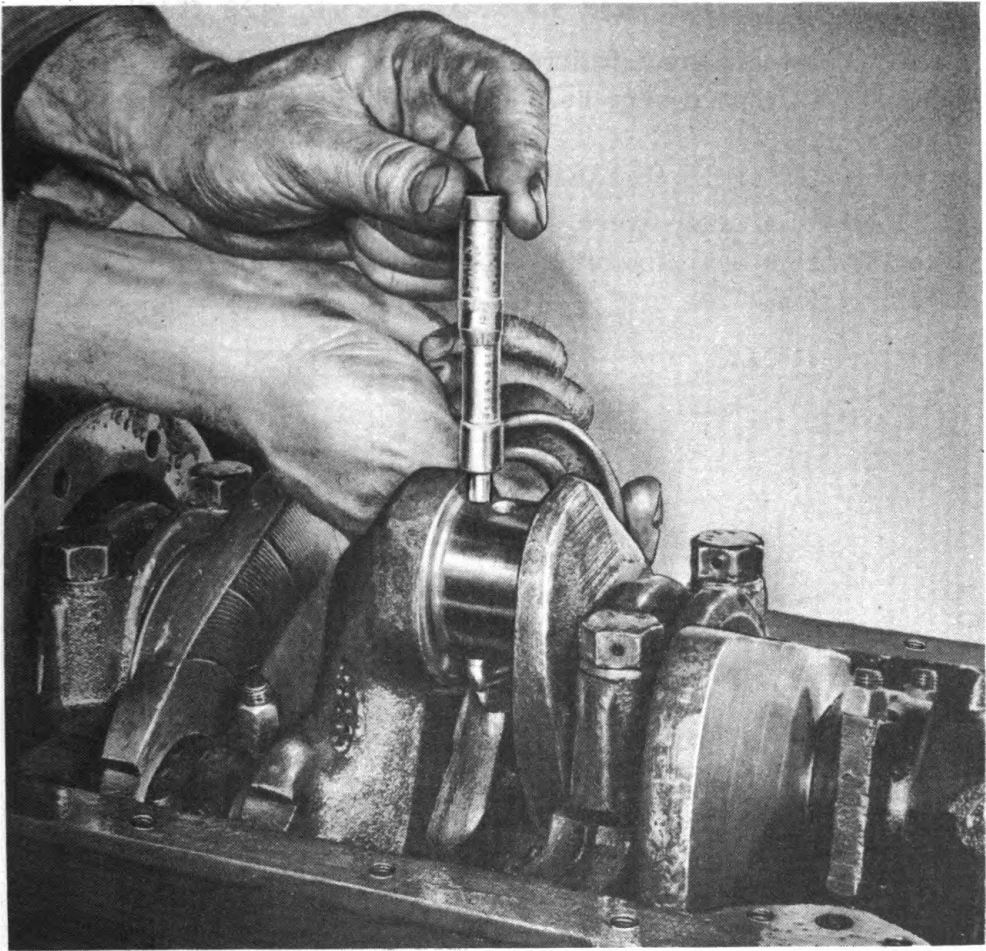

RA PD 67002

Figure 29—Measuring Connecting Rod Crank Pin Journal, Using Micrometer Calipers (Set) 41-C-307

out of ring grooves and oil drain holes, or replace pistons if they are cracked or damaged. If piston pins are scored or too loose, replace them.

38. ENGINE FRONT AND REAR PLATES.

a. Inspect engine plates for cracks or distortion. If plates cannot be placed in serviceable condition by welding or straightening, replace them.

39. CRANKSHAFT.

a. Inspect crankshaft journals for roundness, taper (fig. 29), or scores. If journals are out-of-round or tapered in excess of 0.0015 inch or scored, recondition or replace the shaft. Place crankshaft in V-blocks and check alignment. If misalignment exceeds 0.006 inch, replace crankshaft.

40. ENGINE SUPPORT BRACKET MOUNTINGS (fig. 6).

a. Inspect engine support bracket mounting cushions for signs of deterioration. Examine brackets for cracks, distortion, or other damage.

**ORDNANCE MAINTENANCE — ENGINE, ENGINE ACCESSORIES,
AND CLUTCH FOR CARGO CARRIER M28 (T15)**

If mounting cushions are deteriorated, replace them. Replace engine support brackets if they cannot be placed in serviceable condition.

41. OIL PRESSURE RELIEF VALVE.

- a. Inspect valve for scores, damage, and plugged metering orifice and replace if unfit for further service. Examine valve spring for breakage and replace if broken.

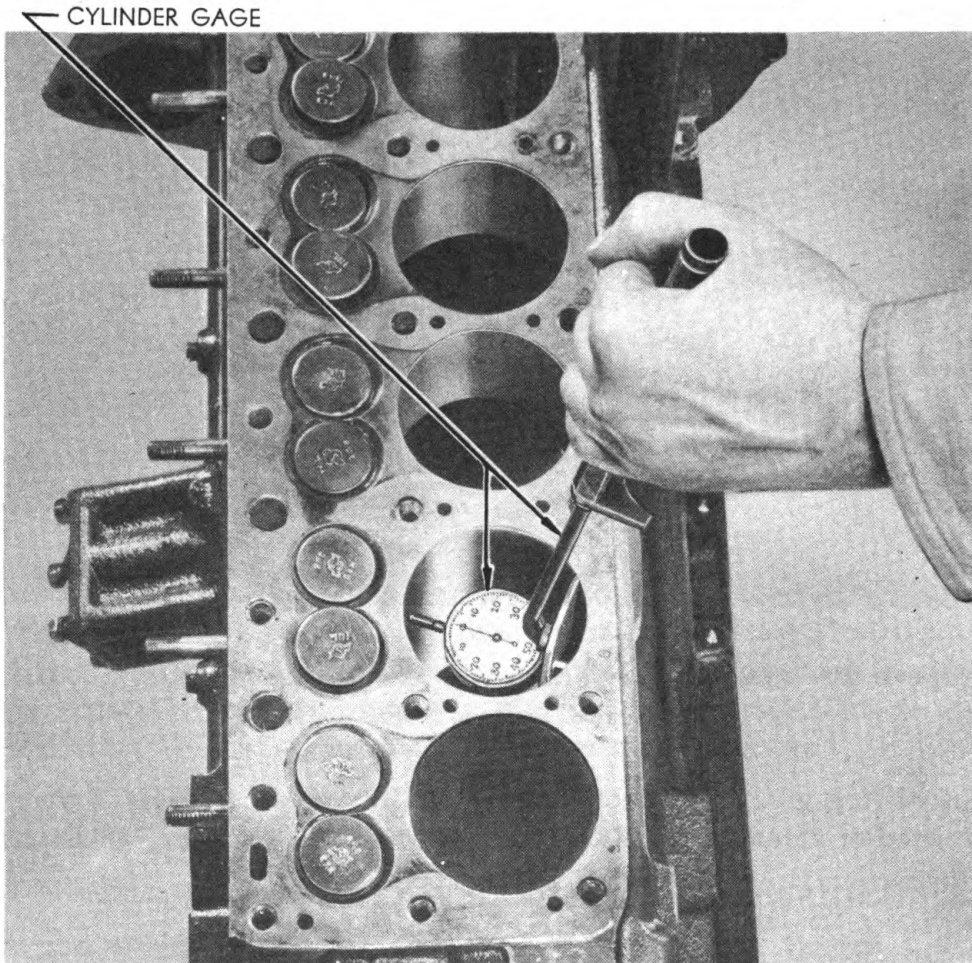

RA PD 66949

Figure 30—Checking Cylinder Bores, Using Dial-type Cylinder Gage 41-C-122

42. CYLINDER BLOCK.

- a. Inspect cylinder block for cracks or indications of water leaks at expansion plugs. Examine valve seats for cracks or a burned and pitted condition. Inspect valve stem guides for breakage or other damage. Inspect cylinder bores for scored, taper, out-of-round condition (fig. 30), and ridge above ring travel. Examine camshaft bearings for scores or other

INSPECTION OF ENGINE PARTS

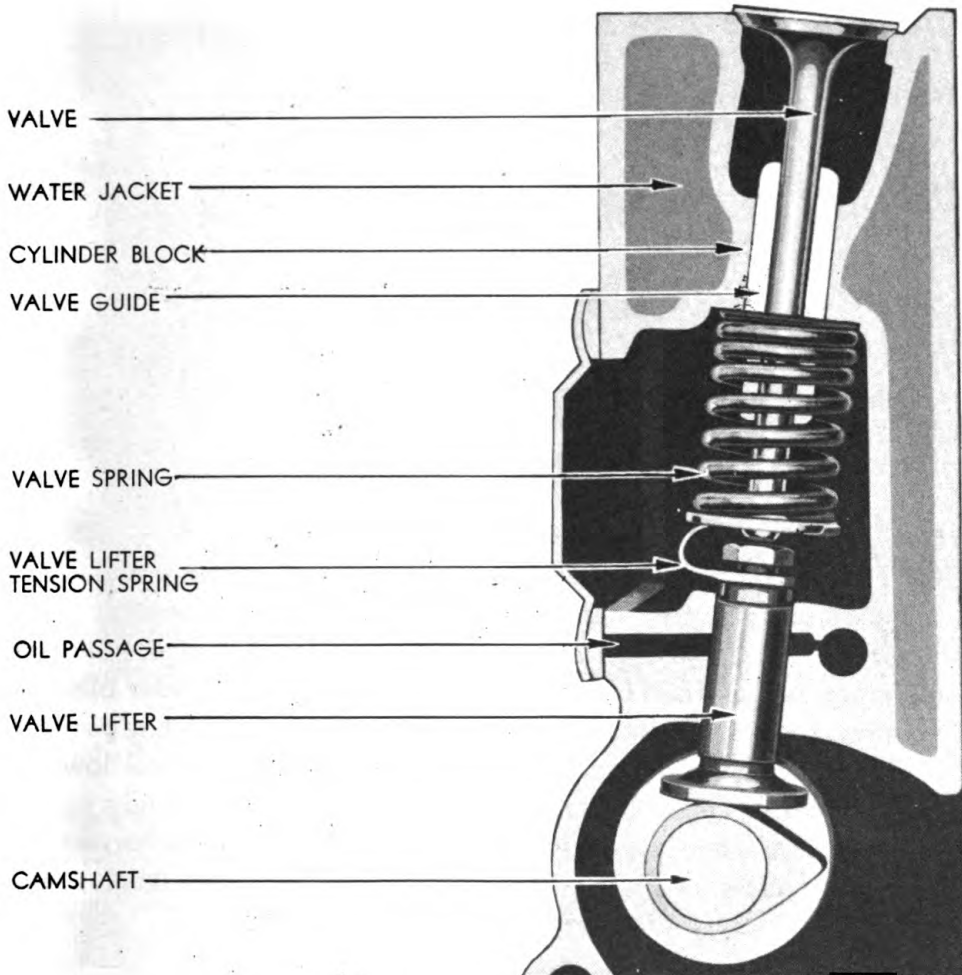

RA PD 49334

Figure 31—Valve and Related Parts

damage. Replace cylinder block if it is cracked and cannot be placed in serviceable condition by welding or other repairs. If water leaks are evident at expansion plugs, replace plugs, applying white lead to them before installing. Recondition valve seats if burned or pitted. Replace broken or damaged valve stem guides. Recondition cylinder bores if scored, tapered, or out-of-round in excess of 0.002 inch. If cylinder bore has a ridge at top, remove it before installing new pistons or rings. Replace camshaft bearings if scored or damaged so they are not satisfactory for further service.

ORDNANCE MAINTENANCE — ENGINE, ENGINE ACCESSORIES,
AND CLUTCH FOR CARGO CARRIER M28 (T15)

CHAPTER 2

ENGINE (Cont'd)

Section IX

REPAIR AND REBUILDING

	Paragraph
Crankshaft	43
Cylinder block.....	44

43. CRANKSHAFT.

a. Recondition crankshaft main bearing and crank pin journals to next undersize and fit new main bearing shells to main bearing journals. The proper main bearing clearance is from 0.0005 inch to 0.001 inch. Place upper half of main bearing shells in position in cylinder block, carefully lower crankshaft in place on shells in block. Select a paper shim 0.001-inch thick (fig. 32), place on journal (fig. 33), install lower shell with main bearing cap and tighten cap screws securely. A slight resistance will be evident when rotating crankshaft if clearance is correct. After checking to make sure there is proper clearance between each crankshaft main bearing journal and shells, remove crankshaft.

b. Fit new connecting rods to crank pin journals by reaming bearing if necessary (fig. 34), to provide 0.0005-inch to 0.001-inch clearance. If necessary, dress off front and rear of connecting rod to provide correct end play of 0.005 inch. The connecting rods are offset, and are properly installed when offset is away from nearest main bearing journal and oil registry hole in side of rod points toward camshaft side of engine. Number connecting rods and caps on side having oil registry hole which sprays oil on thrust side of cylinder wall.

44. CYLINDER BLOCK.

a. **Valve Guides.** To replace valve guides that are broken or damaged, remove them with a suitable tool and install new guides.

b. **Valve Seats.** Recondition the valve seats to a 45-degree angle. Narrow seat down to a $\frac{3}{32}$ -inch width with a 30-degree cutter at top and a 70- or 75-degree cutter at lower edge of seat.

c. **Cylinders.** Recondition cylinders to next piston oversize and fit new pistons to cylinders. Place a 0.002-inch feeler, 1 inch wide, 12 inches

REPAIR AND REBUILDING

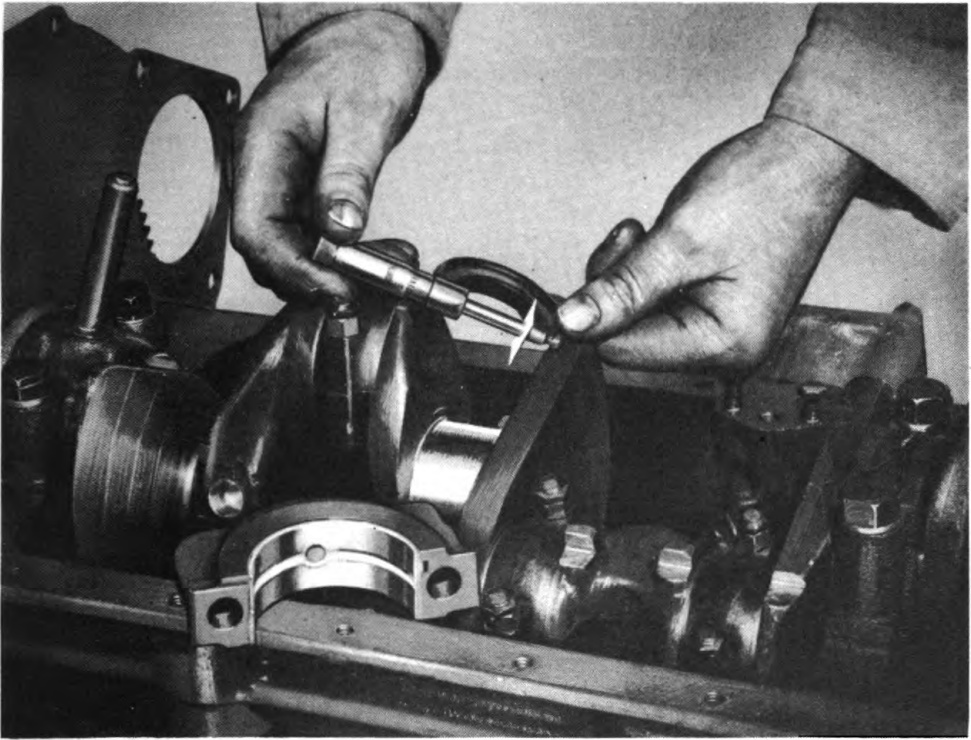

RA PD 66959

Figure 32—Selecting Shim to Check Main Bearing Clearance Using Micrometer Calipers (Set) 41-C-307

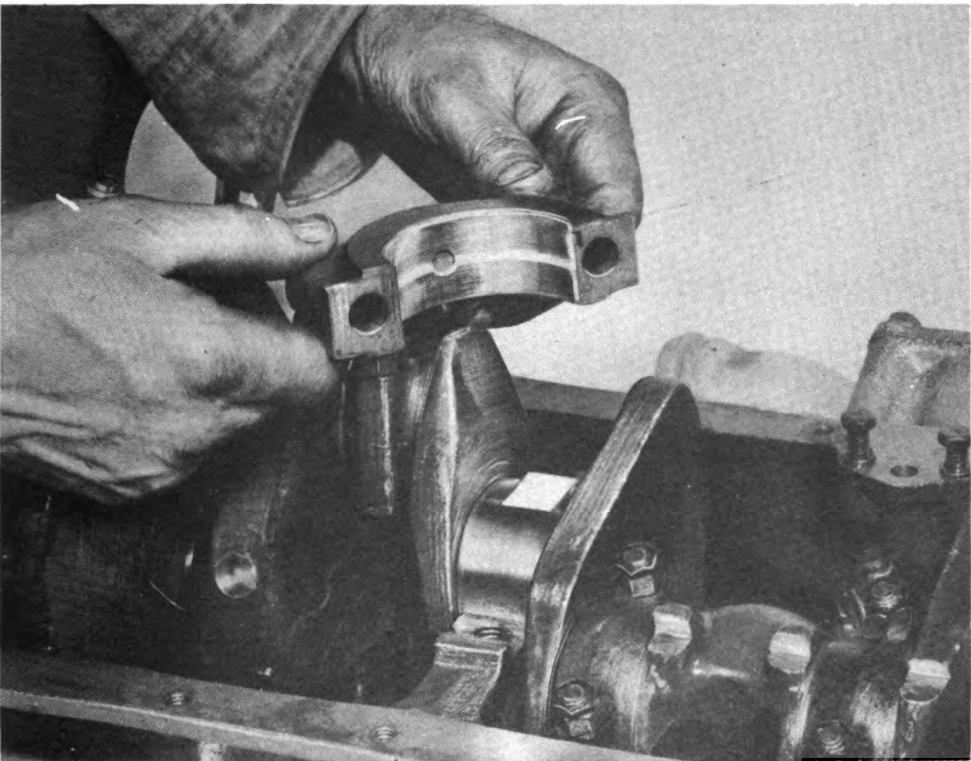

RA PD 66957

Figure 33—Checking Main Bearing Clearance

**ORDNANCE MAINTENANCE — ENGINE, ENGINE ACCESSORIES,
AND CLUTCH FOR CARGO CARRIER M28 (T15)**

Figure 34—Reaming Connecting Rod Bearing

long, attached to piston fitting scale (fig. 35) in cylinder on camshaft (thrust) side, push piston (inverted) into cylinder and pull piston fitting scale to remove feeler while checking the pounds pull required. The proper pounds pull to provide correct piston to cylinder wall clearance is 15 to 20 pounds. Fit new piston rings to each cylinder so a gap of 0.007 inch to 0.017 inch is obtained.

d. Camshaft Bearings. If camshaft bearings are scored or damaged, remove them with a suitable puller and install new bearings carefully to avoid distortion. If bearings are distorted and bind on camshaft journals, it will be necessary to line ream bearings to provide proper clearance.

REPAIR AND REBUILDING

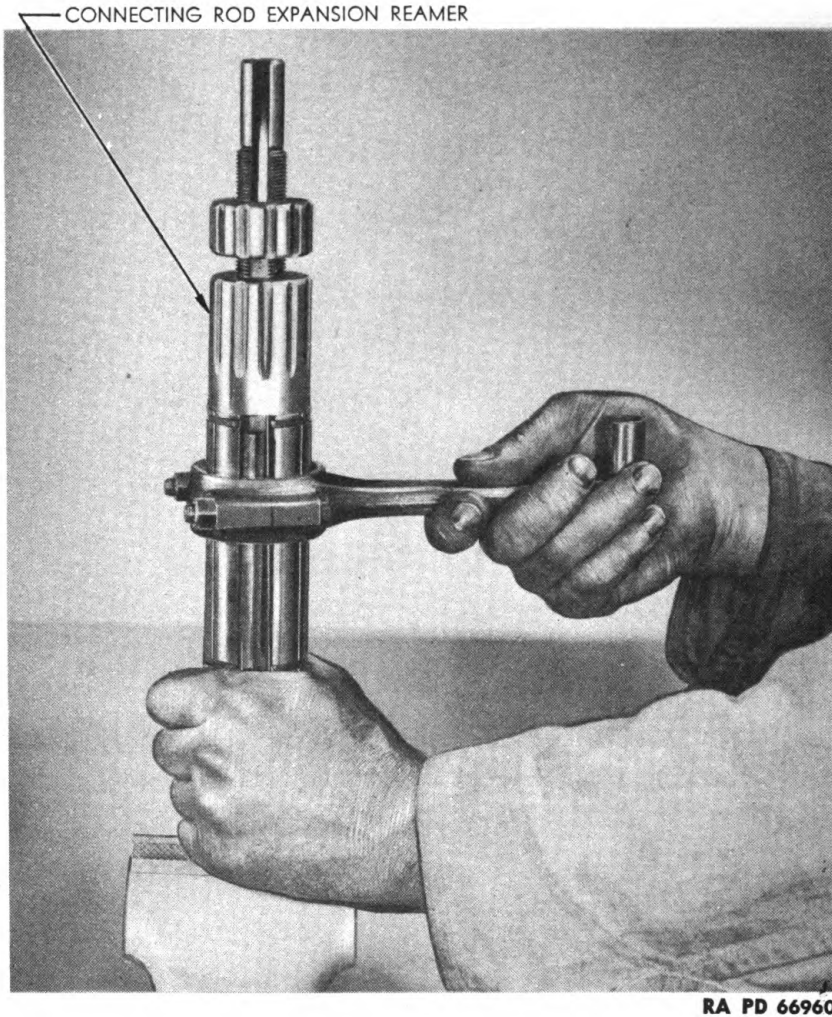
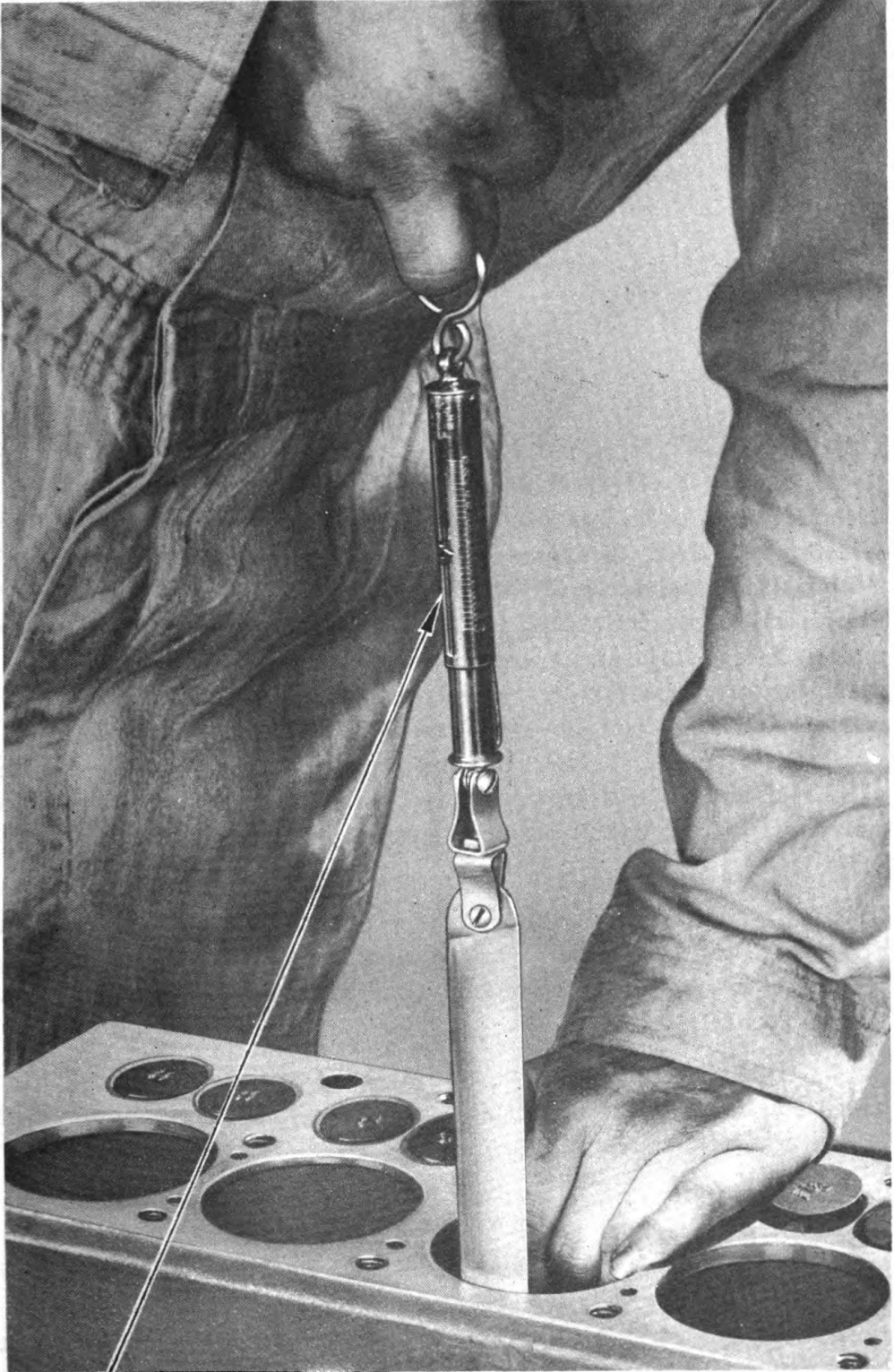

— PISTON FITTING SCALE

RA PD 67184

Figure 35—Checking Piston Fit in Cylinder Bore

ORDNANCE MAINTENANCE — ENGINE, ENGINE ACCESSORIES,
AND CLUTCH FOR CARGO CARRIER M28 (T15)

CHAPTER 2

ENGINE (Cont'd)

Section X

ASSEMBLY

	Paragraph
Assembly	45

45. ASSEMBLY.

a. Assemble Crankshaft to Cylinder Block. With cylinder block inverted, place main bearing upper shells in shell recesses in crankcase webs. Apply SAE 10 engine oil to all moving parts during assembly. With flywheel bolts in position in crankshaft flange carefully place shaft in position on bearing shells. Install main bearing caps with lower shells, making sure that they are correctly positioned. Tighten screws that fasten main bearing caps to block evenly and snugly. Carefully install new specially treated wood oil seals at rear (flywheel end) main bearing cap (fig. 36). Tighten all main bearing cap screws evenly to a tension of 1100 inch-pounds with a tension wrench. Wire together screws holding each main bearing cap in position to prevent screws from loosening.

b. Assemble Engine Front and Rear Plates to Cylinder Block. Install a new gasket on front of cylinder block, place engine front plate in position, install screws and washers, and tighten securely. Place engine rear plate in position on cylinder block, install washers and screws, and tighten securely.

c. Assemble Oil Pressure Relief Valve to Cylinder Block. Insert valve and spring in oil relief passage, place a new gasket on screw plug, install and tighten securely.

d. Assemble Connecting Rods and Piston Assemblies. Fasten piston pin replacer tool (41-R-2395-100) in a vise, remove nut from shaft, slide piston pin over end of shaft, reinstall nut, and tighten. Insert small end of connecting rod between piston pin bosses, making sure that raised boss on inside of piston skirt is toward numbered side of connecting rod. Slide piston and connecting rod over piston pin (held on replacer), insert tapered lock pin through connecting rod while rocking rod, to permit the flat side of tapered pin to aline with flat surface on piston pin. Install toothed lock washer, lock nut, and tighten securely (fig. 37). Install oil

ASSEMBLY

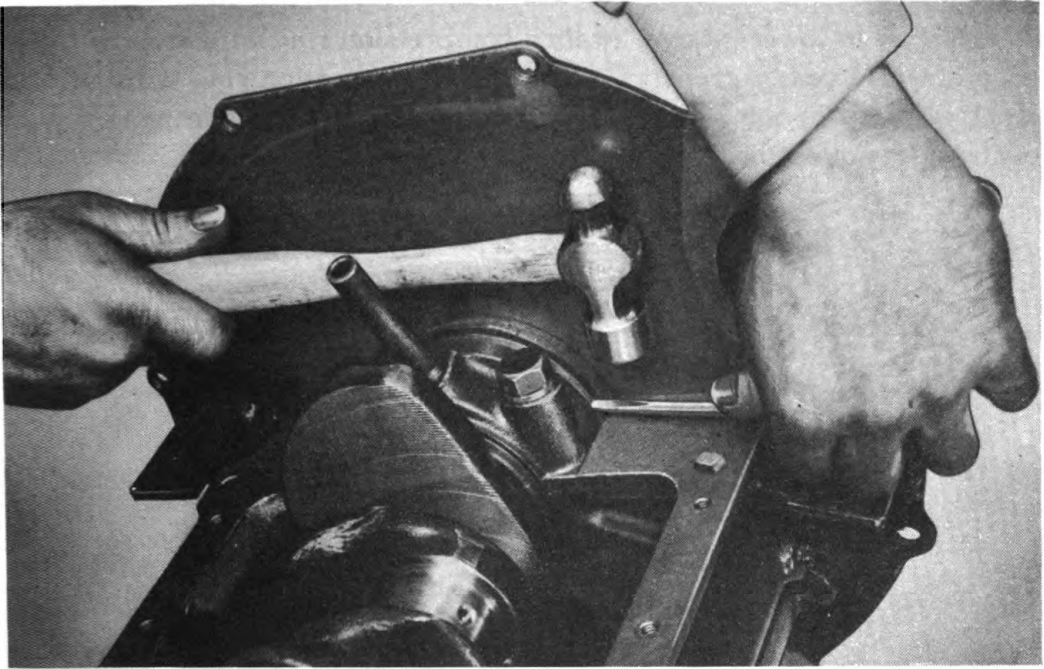

RA PD 66958

Figure 36—Installing Rear Main Bearing in Oil Seal

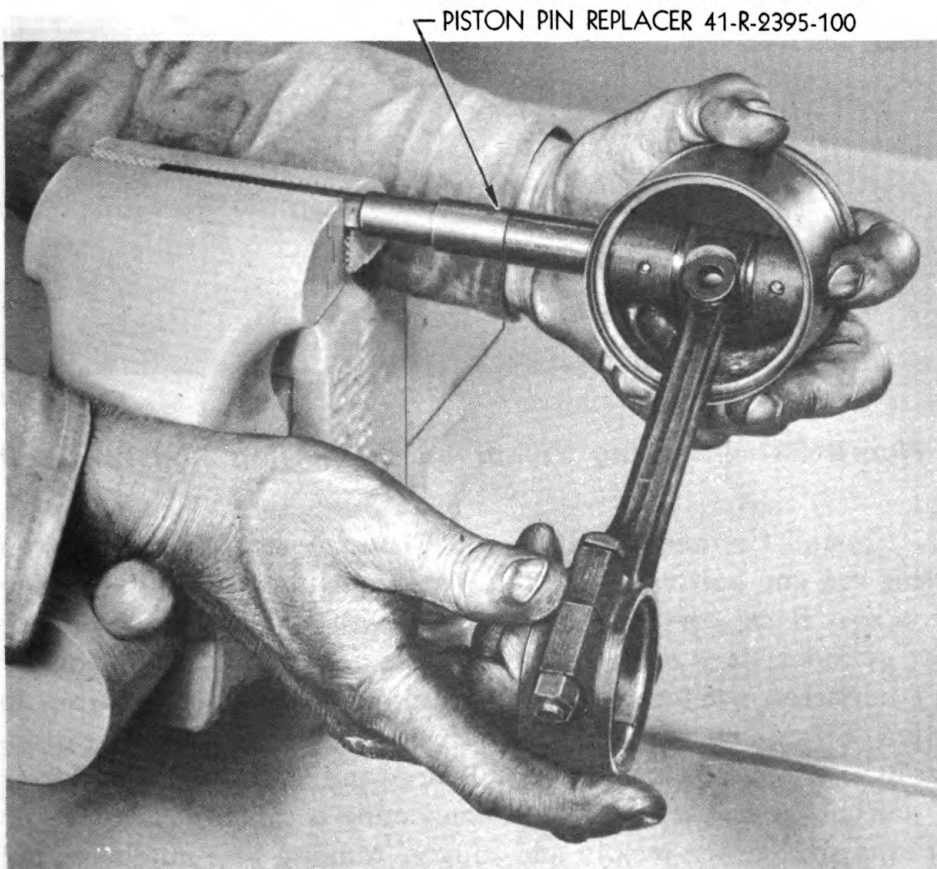

RA PD 66961

Figure 37—Installing Piston and Pin on Connecting Rod

**ORDNANCE MAINTENANCE — ENGINE, ENGINE ACCESSORIES,
AND CLUTCH FOR CARGO CARRIER M28 (T15)**

control ring in lower groove, $\frac{1}{8}$ -inch compression ring with step in outer edge down in center groove, $\frac{3}{32}$ -inch wide compression ring with step in inner edge up in top groove. NOTE: The shallow groove near top of piston does not require a ring.

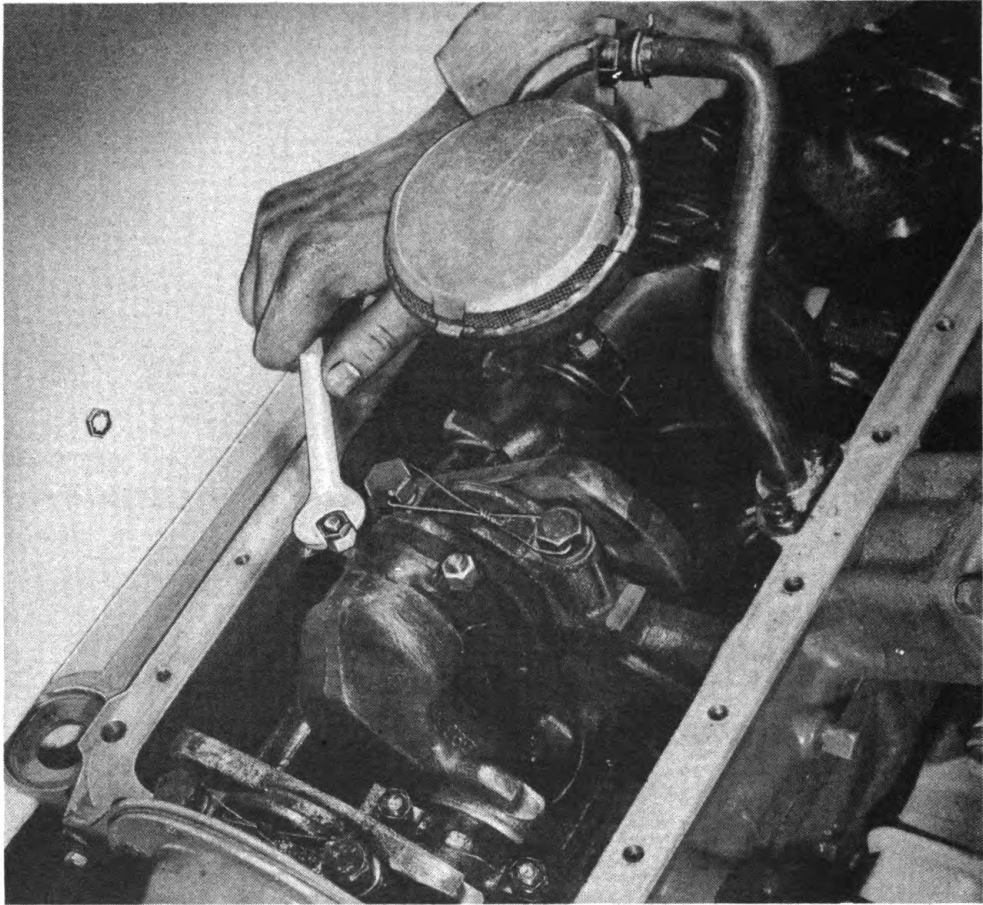

RA PD 66952

Figure 38—Installing Palnut on Connecting Rod Cap Bolt

e. **Install Connecting Rods and Piston Assemblies.** Remove connecting rod cap bolt nuts and cap. Apply engine oil to outer surface of piston and rings; compress piston rings with a piston ring compressor. Place cylinder block in a vertical position, insert large end of connecting rod (numbered side toward camshaft) into cylinder bore, and start lower portion of piston into cylinder bore. Push on top of piston until piston and rings have entered cylinder bore, pull large end of connecting rod to crank pin journal on crankshaft, install connecting rod bearing cap, start cap bolt nuts and tighten evenly and snugly. Making sure numbered side of connecting rod and cap is toward camshaft, tighten rod bolt nuts to a tension of 300 to 325 inch-pounds. Install new palnuts with open face

ASSEMBLY

away from rod bolt nut; tighten until it contacts rod bolt nut and then tighten an additional $\frac{1}{8}$ turn to lock it securely (fig. 38).

f. **Assemble Engine Support Brackets to Cylinder Block.** Place engine support brackets in position, install screws, lock washers, and tighten brackets with cap screws securely.

g. **Install Valve Lifters and Camshaft in Cylinder Block.** Place cylinder block in an inverted position and install valve lifters in lifter guides. Push camshaft into position in cylinder block, being careful to avoid damaging camshaft or bearings. The correct end play of camshaft

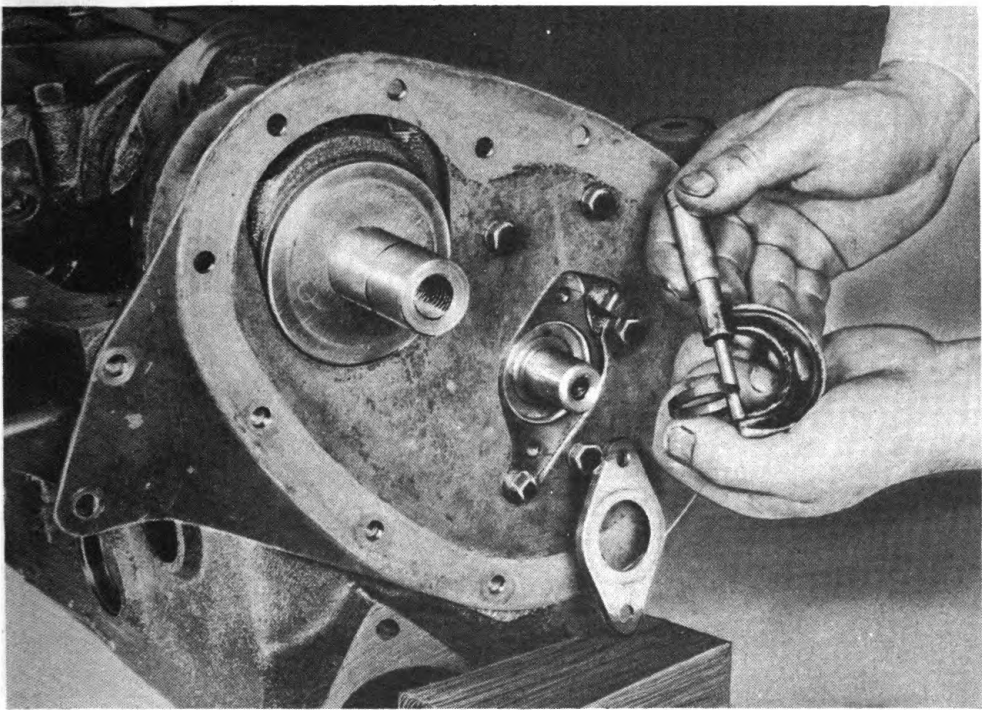

RA PD 66945

Figure 39—Checking Spacer and Plate Governing Camshaft End Play

is from 0.004 inch to 0.008 inch. With a micrometer determine measurement of both thrust spacer and thrust plate (fig. 39). The spacer should be at least 0.004 inch but not more than 0.008 inch thicker than the thrust plate because the end play is controlled by this difference in thickness. Machine the spacer or plate as required to give the correct end play. Place the camshaft thrust spacer and thrust plate into position; install the thrust plate retaining screws and tighten securely.

h. **Assemble Crankshaft Gear to Crankshaft.** Move crankshaft forward until front face of crankshaft front counterweight contacts rear face of front main bearing shell. Place a sufficient amount of shims over front end of crankshaft to give approximately 0.006-inch clearance be-

**ORDNANCE MAINTENANCE — ENGINE, ENGINE ACCESSORIES,
AND CLUTCH FOR CARGO CARRIER M28 (T15)**

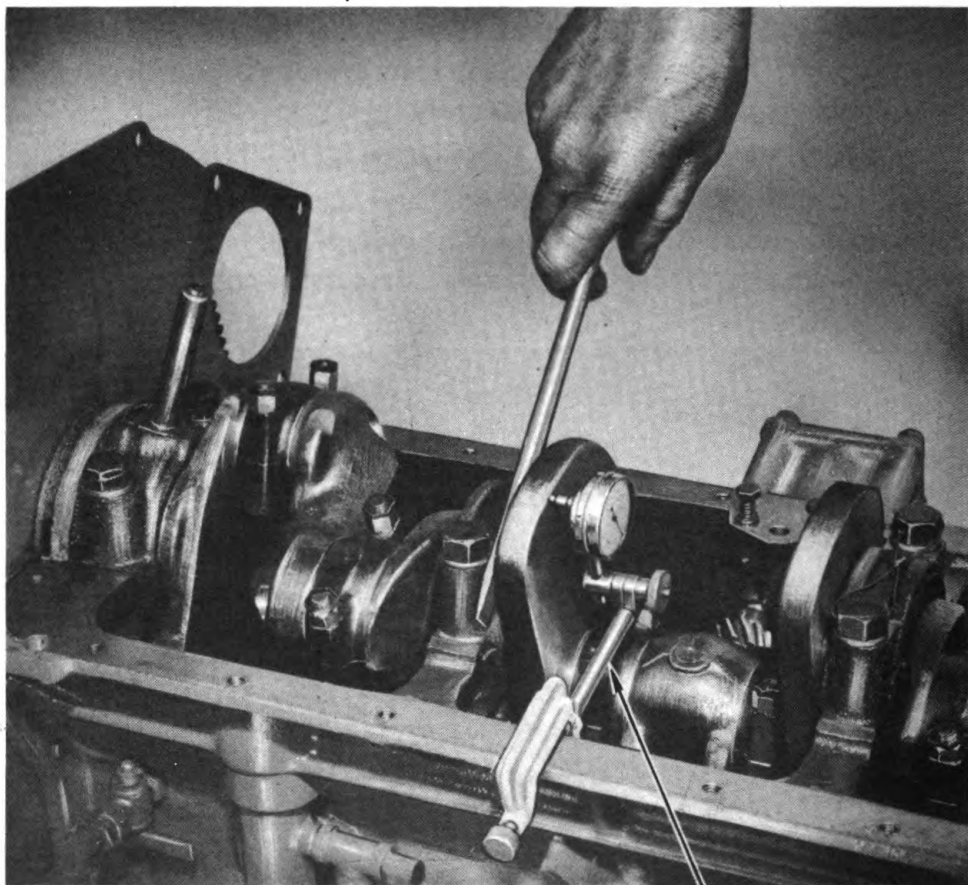

UNIVERSAL DIAL TEST INDICATOR

RA PD 66954

**Figure 40—Checking Crankshaft End Play, Using Universal
Dial Test Indicator 41-I-100**

tween rear face of thrust washer and front face of front main bearing shell. Install a Woodruff key in keyway on crankshaft, apply white lead in bore of crankshaft gear, start gear over end of crankshaft with timing marks on teeth away from cylinder block, and make sure keyway in gear is alined with Woodruff key. Assemble gear pusher set (41-P-4710) to crankshaft and push gear into position. Remove gear pusher set and check end play of crankshaft with a universal type dial indicator to determine if there is at least 0.003-inch and not more than 0.006-inch end play (fig. 40). If end play is less than 0.003 inch it will be necessary to remove crankshaft gear and place additional shims between thrust washer and shoulder of crankshaft.

i. **Assemble Camshaft Gear to Camshaft.** Turn crankshaft until keyway in crankshaft gear is at the top. Install Woodruff key into position on camshaft, turn camshaft until key is away from crankshaft and

ASSEMBLY

alined with center of camshaft and crankshaft using a straightedge to check alinement. Apply white lead to bore of camshaft gear. Start gear over end of camshaft so keyway in gear is alined with key and tooth with mark enters between two marked teeth on crankshaft gear. Assemble gear pusher set (41-P-4710) to camshaft and push gear into position against thrust spacer (fig. 41). Install plain washer, lock washer, fastening screw, and tighten securely.

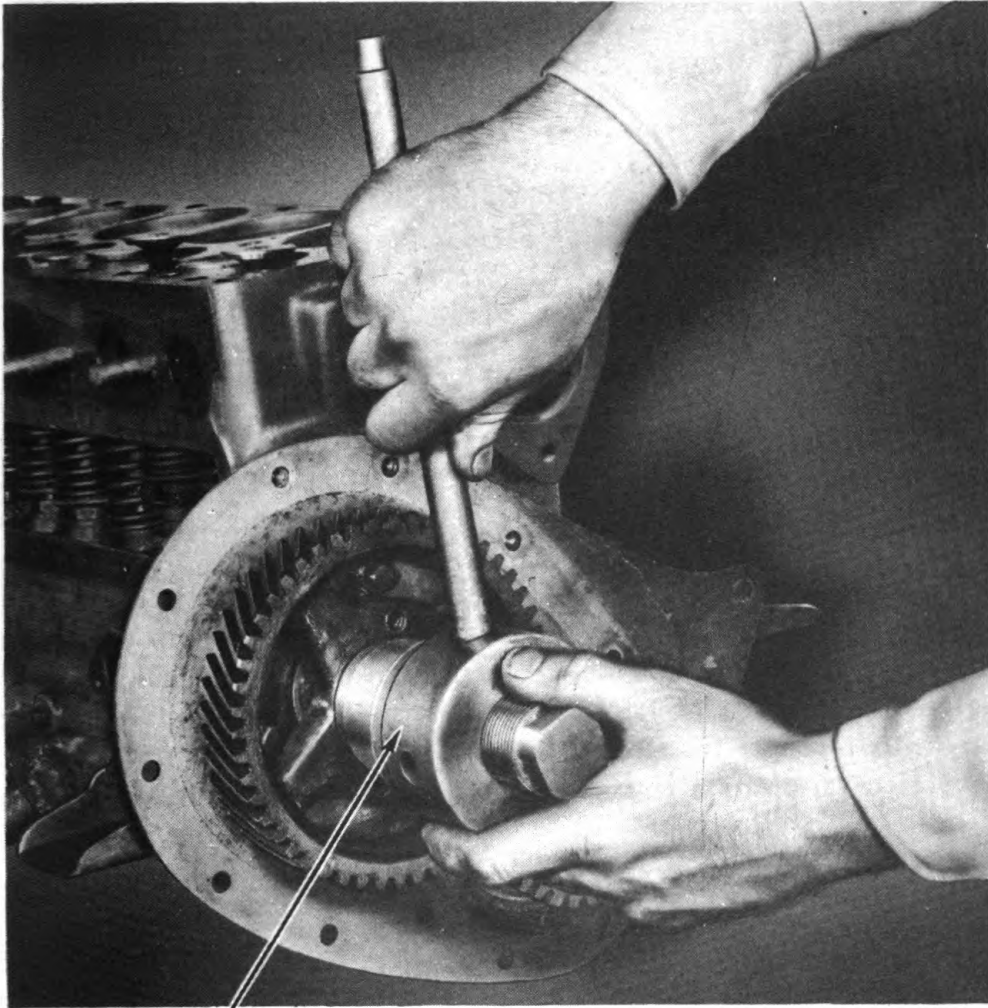

—PUSHER SET 41-P-4710

RA PD 67132

Figure 41—Installing Camshaft Gear

j. Assemble Flywheel to Crankshaft. Place flywheel in position against crankshaft flange on flywheel bolts, install lock washers, and tighten nuts securely.

k. Install Valves and Valve Springs. Place valve springs and retainers in position in valve spring chamber. Install valves in their proper location, compress valve springs with a valve spring compressor, and install a retainer seat on each valve stem. Adjust clearance between upper

**ORDNANCE MAINTENANCE — ENGINE, ENGINE ACCESSORIES,
AND CLUTCH FOR CARGO CARRIER M28 (T15)**

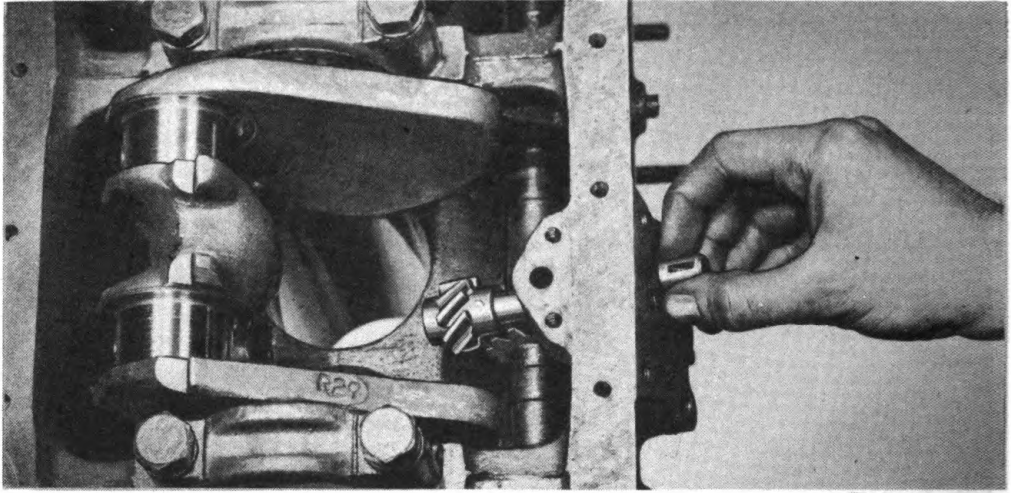

RA PD 67130

Figure 42—Installing Oil Pump Drive Gear and Shaft

face of valve lifter adjusting screw and lower face of valve stem to 0.016 inch. Install a valve lifter tension spring in position on each lifter. Install new valve cover gaskets with gasket sealer and place new gaskets on valve cover fastening screws. Place valve covers in position, install screws, and tighten securely.

1. **Assemble Oil Pump to Cylinder Block.** Turn crankshaft until piston in No. 1 cylinder is in firing position. Insert oil pump drive shaft through bore in side of cylinder block from inside block (fig. 42). When teeth of oil pump drive shaft gear are fully meshed with teeth of gear on camshaft make sure that tongue at upper end of oil pump drive shaft is in a horizontal position (fig. 43). The narrow offset must be toward top

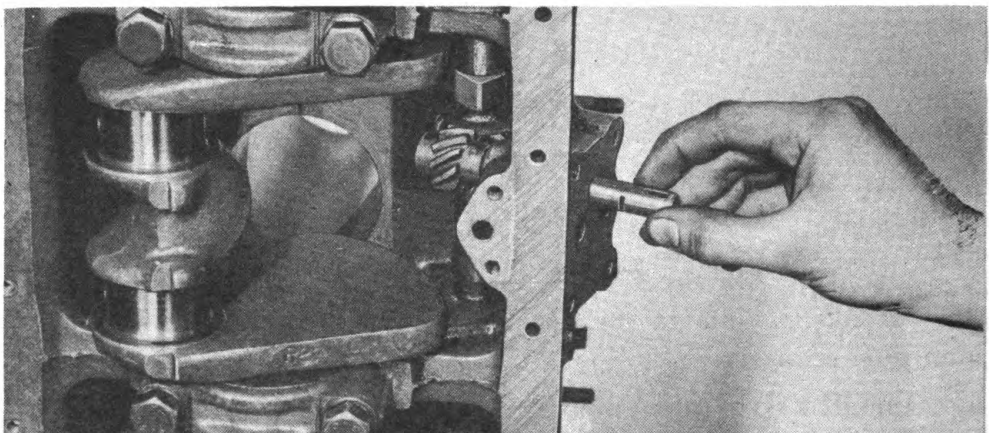

RA PD 67128

Figure 43—Oil Pump Drive Gear and Shaft in Position

ASSEMBLY

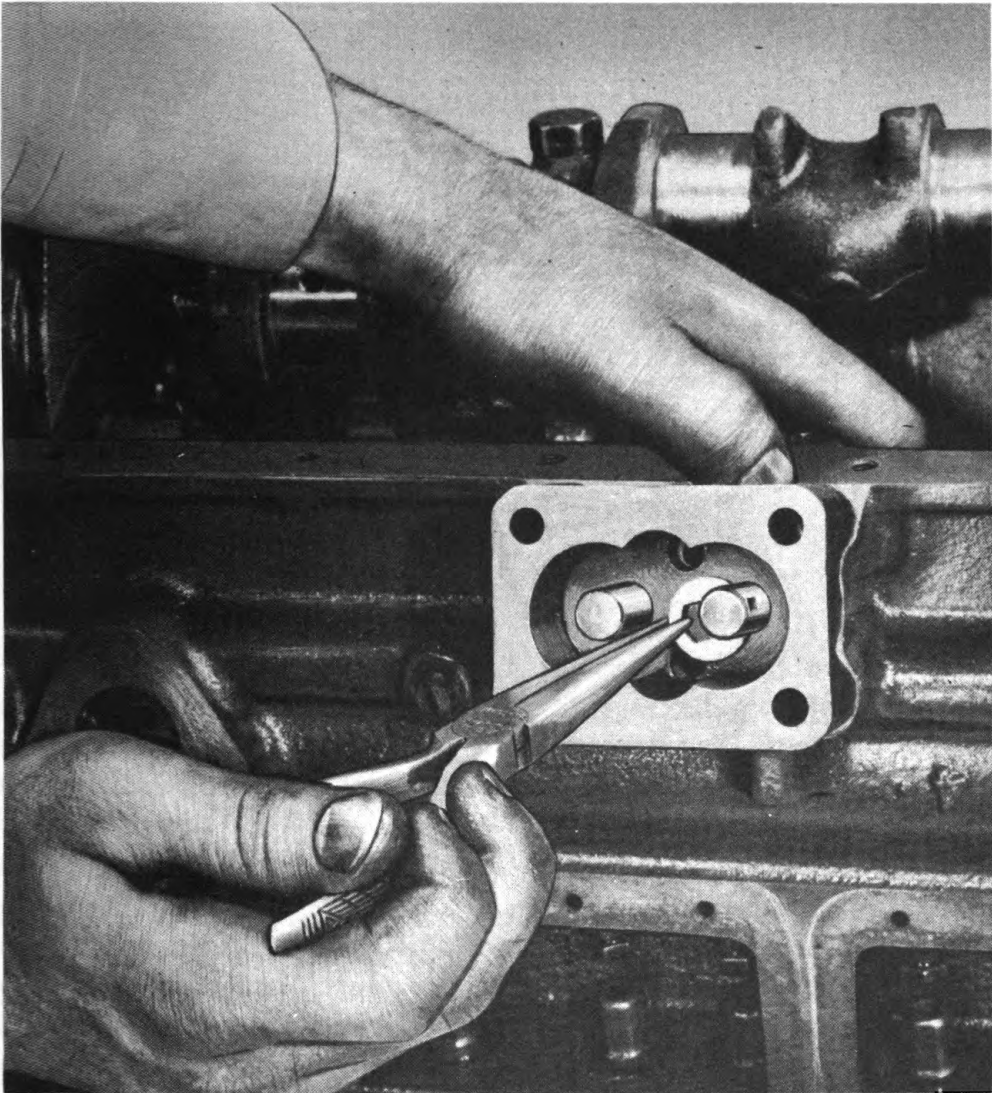

RA PD 67012

Figure 44—Installing Oil Pump Body

for proper ignition timing. Install a new pump body gasket on cylinder block, place pump body in position (fig. 44), and install the C washer into slots on oil pump drive shaft. Install Woodruff key and slide gear onto drive shaft with undercut side of gear toward C washer, and slip idler gear on idler shaft. Install a new cover gasket on pump body, place cover in position and fasten cover and body securely with cap screws.

m. Install Timing Gear Cover and Crankshaft Pulley. Install a new gasket in position on engine front plate after applying gasket sealer. Place oil throw ring over end of crankshaft and against crankshaft gear, place timing gear cover in position, install screws, bolts, lock washers, and nuts, leaving cover loose. Install fan pulley Woodruff key in keyway near front end of crankshaft, apply white lead in bore of pulley hub, aline keyway in pulley hub with Woodruff key in crankshaft, and push pulley into

**ORDNANCE MAINTENANCE — ENGINE, ENGINE ACCESSORIES,
AND CLUTCH FOR CARGO CARRIER M28 (T15)**

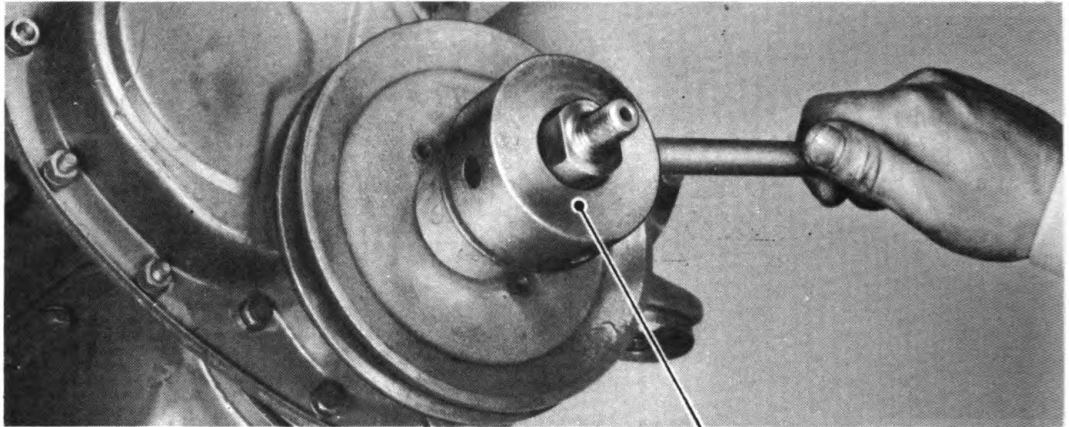

PUSHER SET 41-P-4710

RA PD 309980

Figure 45—Installing Crankshaft Pulley

position (fig. 45) with gear pusher set (41-P-4710). Turn crankshaft several revolutions to align timing gear cover oil seal with machined surface of crankshaft pulley hub. Tighten timing gear cover screws, bolts, and nuts securely. Install starting jaw lock plate and fasten in position with screws. Screw starting jaw into end of crankshaft and bend a portion of lock plate over flat on starting jaw.

n. **Assemble Cylinder Head to Cylinder Block.** Install a new cylinder head gasket into position on cylinder block after applying gasket sealer to lower face of gasket and machined surface of cylinder head. Place cylinder head in position on gasket, being careful to avoid damaging valve heads. Install cylinder head cap screws with brackets required for accessory mountings. Place thermostat spacer in cylinder head, set thermostat on spacer (with bellows down), install gasket on thermostat, place water outlet gasket on cylinder head after applying gasket sealer, and install water outlet with cylinder head cap screws and tighten moderately. Tighten all cylinder head cap screws progressively in sequence shown on tightening chart (fig. 46) to a tension of 600 to 650 inch-pounds with a

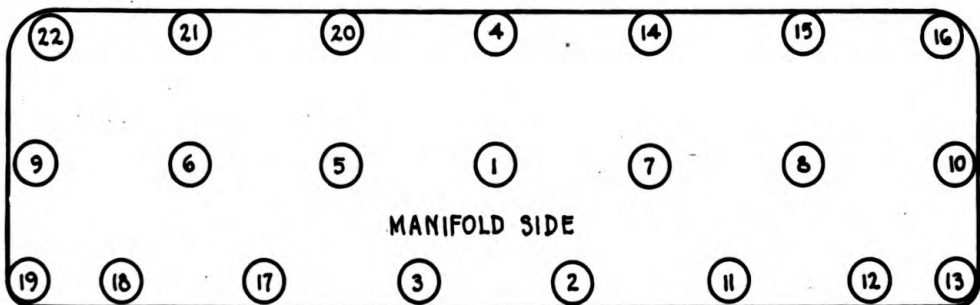

RA PD 49276

Figure 46—Cylinder Head Cap Screw Tightening Chart

ASSEMBLY

TENSION WRENCH

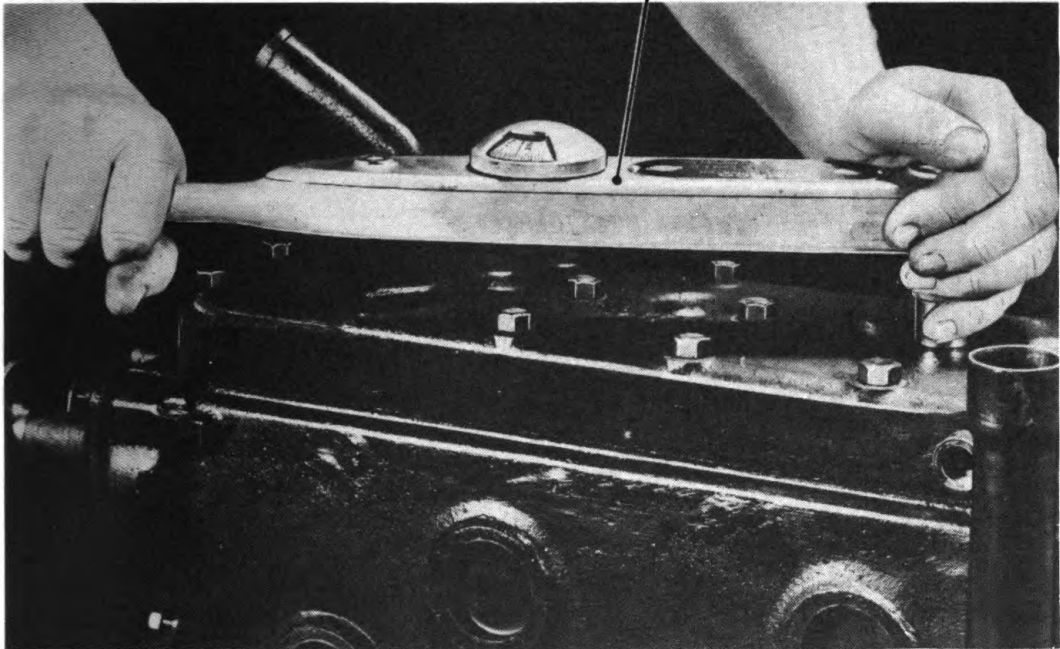

RA PD 66947

Figure 47—Tightening Cylinder Head Screws, Using Tension Wrench 41-W-3630

tension wrench (fig. 47). Check cylinder head cap screws with a tension wrench after engine has been installed and operated at normal operating temperature for a short time.

o. Assemble Oil Strainer Assembly. Assemble oil strainer to support with ribbed cover up and fasten in position with a new cotter pin. Place a new gasket on machined surface of cylinder block, hold strainer support in position, install and tighten screws securely.

p. Assemble Oil Pan to Cylinder Block. Apply gasket sealer to new oil pan gaskets and place them in position. A rubber band will be helpful in holding filler block gasket to filler block. Aline filler block holes with holes in engine front plate by using a drift, install timing gear cover to filler block screws and tighten securely. Install pilot screws in lower flange of cylinder block to guide oil pan into position, install oil pan (screws with lock washers), and tighten securely.

ORDNANCE MAINTENANCE — ENGINE, ENGINE ACCESSORIES,
AND CLUTCH FOR CARGO CARRIER M28 (T15)

CHAPTER 2

ENGINE (Cont'd)

Section XI

INSTALLATION OF ACCESSORIES

	Paragraph
Manifold assembly	46
Carburetor	47
Spark plugs	48
Oil filter assembly	49
Fuel pump	50
Water pump	51
Distributor and wiring	52
Ignition coil	53
Generator	54
Clutch and housing	55
Starter	56
Transmission	57

46. MANIFOLD ASSEMBLY.

a. Install a new manifold to block gasket in position on manifold studs (fig. 48) so raised rings are away from cylinder block. Place manifold in position, install holding clamps and nuts, and tighten manifold securely to block. Install intake manifold to valve cover ventilation pipe and tighten connections securely.

47. CARBURETOR.

a. Place a new carburetor flange gasket on manifold, set carburetor on gasket, install nuts, and tighten them evenly and securely. Remove cylinder head cap screw No. 17 and reinstall it after placing it through air cleaner elbow support, and tighten to proper tension. Connect crankcase ventilator pipe to carburetor air cleaner elbow, oil filler tube, and tighten securely.

48. SPARK PLUGS.

a. Place a new gasket on each spark plug so seam will be toward cylinder head; install spark plugs and tighten until gasket is compressed.

INSTALLATION OF ACCESSORIES

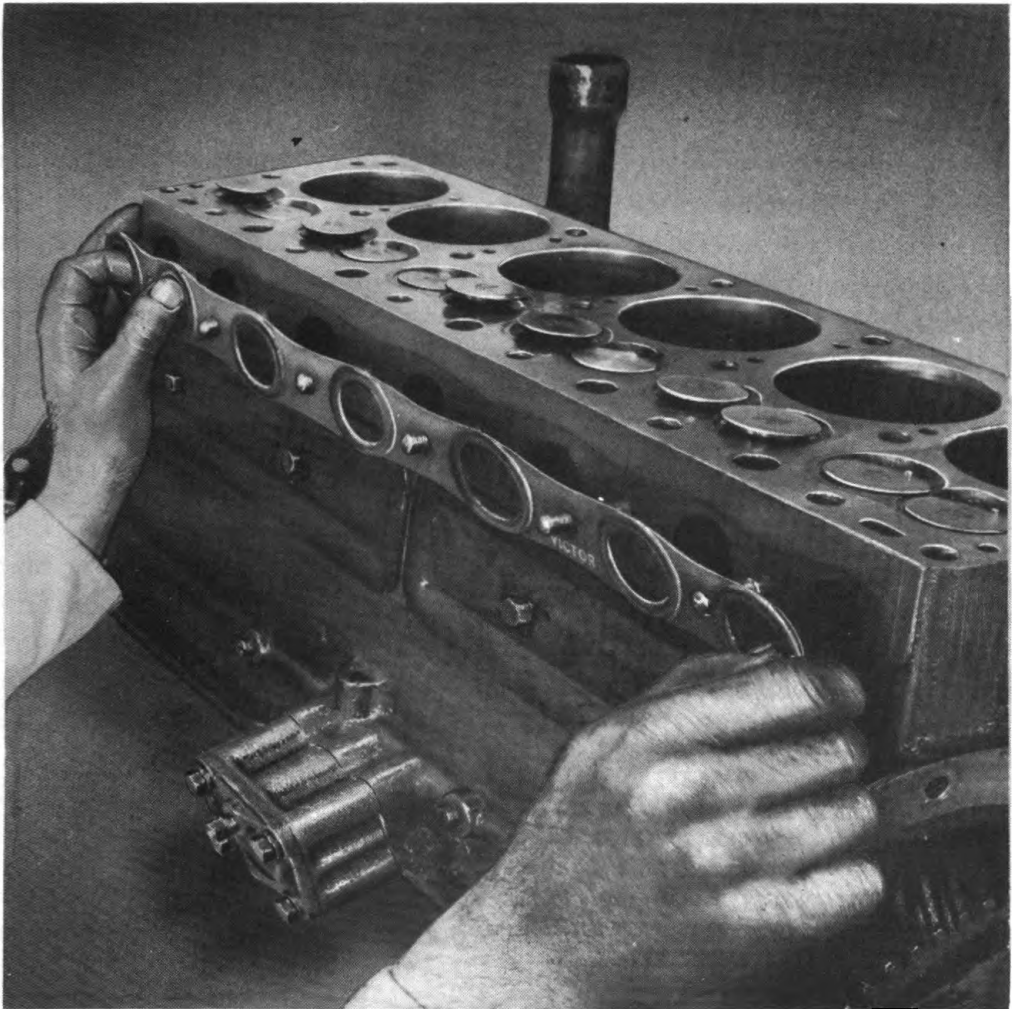

RA PD 66955

Figure 48—Installing Manifold Gasket

49. OIL FILTER ASSEMBLY.

a. Remove cylinder head cap screws that anchor filter and diluter bracket to cylinder head, place filter and diluter with bracket in position, reinstall cap screws, and tighten to proper tension. Install oil filter intake line to filter and crankcase fittings, and outlet pipe to bottom of filter and lower end of oil filler tube, and tighten securely to fittings.

50. FUEL PUMP.

a. Place a new fuel pump to block gasket on machined pad on manifold side of cylinder block, using joint and thread compound to hold it in position. Insert pump operating arm through the opening in the block, making sure the lower side of the arm contacts the lobe on camshaft. Install cap screws and tighten securely. Connect fuel pump inlet pipe, and primer inlet pipe and coupling, to fuel pump. Connect the fuel pump to

**ORDNANCE MAINTENANCE — ENGINE, ENGINE ACCESSORIES,
AND CLUTCH FOR CARGO CARRIER M28 (T15)**

carburetor pipe to the fuel pump and carburetor fittings, and tighten securely.

51. WATER PUMP.

a. Install a new water pump to block gasket on cylinder block, using joint and thread compound to hold it in position. Place water pump assembly in position, coat cap screw threads with white lead, install, and tighten them securely.

52. DISTRIBUTOR AND WIRING.

a. Turn crankshaft until No. 1 piston is on compression stroke and continue until mark "UDC1-6" on flywheel is directly under pointer. Place a new distributor base gasket in recess around base bore in block. Insert lower end of distributor drive shaft through bore in side of cylinder block. Turn shaft with rotor until slot in lower end engages with tongue in oil pump drive shaft gear. Install clamp arm, hold-down screw, and tighten securely. Loosen clamp bolt and rotate distributor, right or left, until breaker points just start to open. Connect spark plug wires to terminals on spark plugs, and primary wire to terminal on distributor.

53. IGNITION COIL.

a. Remove cylinder head screw No. 22, place coil in position, install cylinder head screw, and tighten to proper tension. Connect primary and secondary wires to coil.

54. GENERATOR.

a. Place generator in position and install fastening bolts and nuts. Connect wires to generator terminals and tighten securely.

55. CLUTCH AND HOUSING.

a. **Install Clutch Assembly.** Coat clutch pilot bushing in flywheel with suitable lubricant. Place clutch driven plate with facings against machined surface of flywheel with longest extension of driven plate hub away from flywheel. Insert universal expanding pilot type clutch plate alining tool (41-T-3085) through hub of driven plate and into clutch pilot bushing in flywheel. Place pressure plate assembly in position against facing on driven plate, install cap screws through pressure plate cover flange, and tighten them evenly and progressively about ½ turn at a time to avoid distorting cover. Give screws a final tightening to make certain that pressure plate is securely fastened to flywheel and remove lining arbor.

INSTALLATION OF ACCESSORIES

b. **Install Clutch Housing.** Place housing in position against engine rear plate and start a cap screw at top to preserve general alinement. Move housing as required to line up right and left dowel bolt holes and tap dowel bolts into place with heads toward engine block. When installing a new housing, do not place dowel bolts in position until housing has been properly alined. Install all bolts, lock washers, and nuts, excluding starter fastening bolts and nuts, and tighten moderately. Install all cap screws and tighten moderately. Insert clutch alinement arbor (KM-J3618) through clutch housing bore, until pin enters pilot bushing in flywheel, and move housing, as required, until alining plate enters transmission pinion flange bore in clutch housing. Tighten cap screws and bolt nuts alternately, and progressively, to preserve alinement.

56. STARTER.

a. Place starter flange in position against engine front plate, install bolts, lock washers, nuts, and tighten securely. Connect starter to solenoid cable at terminal on starter.

57. TRANSMISSION.

a. Insert pinion through clutch housing bore and rotate, as required, so that pinion splines mesh with splines in clutch driven plate. Install cap screws and tighten transmission securely to clutch housing.

**ORDNANCE MAINTENANCE — ENGINE, ENGINE ACCESSORIES,
AND CLUTCH FOR CARGO CARRIER M28 (T15)**

CHAPTER 2

ENGINE (Cont'd)

Section XII

INSTALLATION AND TEST OF ENGINE

	Paragraph
Install engine	58

58. INSTALL ENGINE.

a. Place Engine in Vehicle. Install engine mounting bolts, and mounting lower insulators in hull brackets in engine compartment. Use tape to hold engine bolts and insulators in place while lowering engine into position. Raise engine with a hoist and slowly lower it into engine compartment, guiding it carefully to avoid damaging uncoupled pipes, wires, and controls, and then move engine rearward, as required, and lower into position on hull brackets. Install upper insulator washers and nuts on engine mounting bolts. Tighten nuts until firm contact is made between insulated mounting spacer tube and hull bracket. Install new cotter pins. Place shim between engine transmission support mounting and pad on floor of hull. Install screws and tighten securely, making sure that clutch control cable conduit bracket is in position under screw head on left side. Remove hoist, lift chain, and eyebolts. Install cylinder head screws No. 9 and No. 10 and tighten to proper tension.

b. Connect Remote Control Shift Rods and Clutch Control Cable. Connect engine transmission shift rods to external shift levers on transmission with clevis pins and new cotter pins. Connect clutch control cable clevis to release shaft operating arm with clevis pin and new cotter pin. Hook return spring to clutch release shaft outer lever.

c. Install Propeller Shaft. Start slip joint on transmission mainshaft splines. Lower front end of propeller shaft and move shaft forward until free bearings enter the recesses in axle unit driving flange. Use universal joint clamp to compress free bearing seals so bearings will seat properly between retaining lugs in driving flange recesses. Install U-clips, nuts, and lock washers, and tighten securely. Place propeller shaft cover in position and fasten securely with cap screws.

d. Connect Generator Wires and Engine Ground Strap. Fasten wires to proper terminals on generator. Connect engine ground strap to left rear hull bracket.

INSTALLATION AND TEST OF ENGINE

e. Connect Exhaust Pipe. Place lower end of flexible exhaust pipe over upper end of lower pipe and fasten securely in clamp.

f. Connect Primer Lines, Engine Heat Indicator, Oil Pressure Gage, and Ignition Coil. Install inlet and outlet pipes. Install heat indicator element into adapter in cylinder head and tighten securely. Connect oil pressure gage pipe to flexible coupling. Connect harness wire to terminal on ignition coil and place high-tension wire in coil tower.

g. Connect Choke and Throttle Controls and Fuel Tank Line. Fasten choke control conduit to bracket; connect choke control wire to choke valve lever and adjust to operate choke valve properly. Fasten throttle control cable tube to clip, connect throttle control clevis to throttle valve operating arm with clevis pin, and hook pull back spring to clevis pin. Connect fuel tank to fuel pump line coupling to fuel pump pipe.

h. Install Radiator with Fan Shroud, Fan Pulley and Blades, and Rear Air Duct. Place radiator with fan shroud in position, install metal screws, and tighten flanges securely to hull frame. Apply liquid soap to inside of hose at each end, install and tighten hose clamp screws securely. Hold fan pulley and blades (positioned to push air out rear) against water pump shaft flange, install cap screws, and tighten securely. Install fan belt on pulleys, adjust to proper tension ($\frac{3}{4}$ -inch deflection), and tighten generator adjusting arm pivot screw and hinge bolt nuts. Place rear air duct in position against rear of hull, install cap screws, and tighten securely. Make sure sponge rubber gasket provides a good seal.

i. Install Bulkhead with Units Attached. Place bulkhead with starter solenoid switch, voltage regulator, fire extinguisher, and demolition timer control in vehicle and fasten securely to bulkhead frame. Insert demolition timer control wire through hole in bulkhead, fasten wire to plug, and install plug in socket on bottom of timer control box. Fasten wiring harness to front of bulkhead, and primer lines to rear of bulkhead. Connect wires to proper terminals on current and voltage regulator and external filter. Connect wires to proper terminals on starter solenoid switch.

j. Install Air Cleaner and Engine Oil. Place air cleaner in position on air intake elbow and tighten clamp screw. Fill crankcase to proper level with engine oil of correct viscosity. Refer to TM 9-893.

k. Fill Cooling System, Connect Battery, and Install Battery Compartment Cover. Fill cooling system to proper level. Connect battery ground strap clamp to negative post on battery, and tighten securely. Place battery compartment cover in position and fasten securely with cap screws.

l. Install Engine Compartment Front Lid and Hinge. Place front lid with hinge and cross brackets in position and fasten hinge and cross brackets securely with screws, bolts, and nuts.

**ORDNANCE MAINTENANCE — ENGINE, ENGINE ACCESSORIES,
AND CLUTCH FOR CARGO CARRIER M28 (T15)**

m. Install Engine Compartment Lid. Place lid and hinge assembly in position and fasten securely to coaming with bolts and nuts.

n. Install Engine Compartment Front Lid Screen. Place front lid screen in position and install machine screws, flat washers, toothed lock washers, lock washers, double toothed lock washers, and nuts. Make sure double toothed lock washers are installed between screen and brackets to provide a positive ground at these points. Install front lid adjusting arm hand wheels.

o. Install Seats. Install rear seat assembly into brackets and fasten in position with cotter pins. Place front seat assembly in cockpit and fasten securely to sides of hull with cap screws.

p. Test Engine. Start engine and check oil pressure gage. If oil pressure gage does not show pressure, stop engine immediately and investigate. Inspect engine for oil and water leaks, and if leaks are present, eliminate them at once. Test engine for proper operation after it reaches normal operating temperature. Adjust carburetor and linkage (par. 69). Set ignition timing (par. 107).

q. Install Vehicle Top and Bows. Install bows in sockets and fasten in position with cotter pins. The bow with four eyelets at the center is to be installed in front. Place top in position over bows and lash it securely to windshield frame. Stretch top to rear, and fasten to rear and side coaming.

CHAPTER 2
ENGINE (Cont'd)

Section XIII

FITS AND TOLERANCES

Engine service data	Paragraph 59
-------------------------------	-----------------

59. ENGINE SERVICE DATA.

a. Crankshaft.

End play	0.003 to 0.006-in.
End thrust	Carried on front bearing (timing gear end)
Main bearing clearance	0.0005 to 0.0025-in.
Main bearing journal diameters	2.437 to 2.4375-in.
Main bearing journal length	No. 1—1 ⁵ / ₁₆ -in.
	No. 2—1 ¹ / ₈ -in.
	No. 3—1 ¹ / ₈ -in.
	No. 4—1 ¹⁷ / ₃₂ -in.

b. Pistons and Rings.

Ring width—oil	⁵ / ₃₂ -in.
—compression	³ / ₃₂ and ¹ / ₈ -in.
Ring gap	0.007 to 0.017-in.
Piston clearance (thrust side)	15 to 20 lb pull on feeler 0.002 in. thick and 1 in. wide

c. Valves.

Valve stem diameter	⁵ / ₁₆ -in.
Valve lift	⁵ / ₁₆ -in.
Valve to tappet operating clearance	Intake 0.016-in. cold Exhaust 0.016-in. cold
Valve seat angle	45°
Narrowing cutter angle	Top 30° Bottom 70° to 75°
Valve head diameter	Intake 1 ¹¹ / ₃₂ -in. Exhaust 1 ⁹ / ₃₂ -in.
Valve spring pressure	77 to 85 lb—at 1 ⁷ / ₁₆ -in.

d. Valve Timing.

Valve tappet clearance	0.020-in.
Intake opens	15° before U.D.C.
Intake closes	49° after L.D.C.
Exhaust opens	54° before L.D.C.
Exhaust closes	10° after U.D.C.

**ORDNANCE MAINTENANCE — ENGINE, ENGINE ACCESSORIES,
AND CLUTCH FOR CARGO CARRIER M28 (T15)**

e. Connecting Rods and Pins.

Pin diameter	0.7491 to 0.7495-in.
Crankpin journal—diameter	1.81175 to 1.81275-in.
Crankpin journal—length	1.123 to 1.126-in.
Connecting rod bearing clearance	0.0005 to 0.002-in.
Connecting rod bearing end play	0.005 to 0.009-in.

CHAPTER 3
FUEL SYSTEM

Section I

DESCRIPTION AND DATA

	Paragraph
Description	60
Data	61

60. DESCRIPTION.

a. The fuel system is composed of a fuel tank, mechanically operated fuel pump, carburetor, carburetor air cleaner, and hand-operated primer (fig. 49).

61. DATA.

Tank (capacity)	35 gallons
Gages	Electric
Pump	Diaphragm
Primer	Pump
Carburetor air cleaner.....	Oil-coated
Carburetor.....	Carter-BBT downdraft

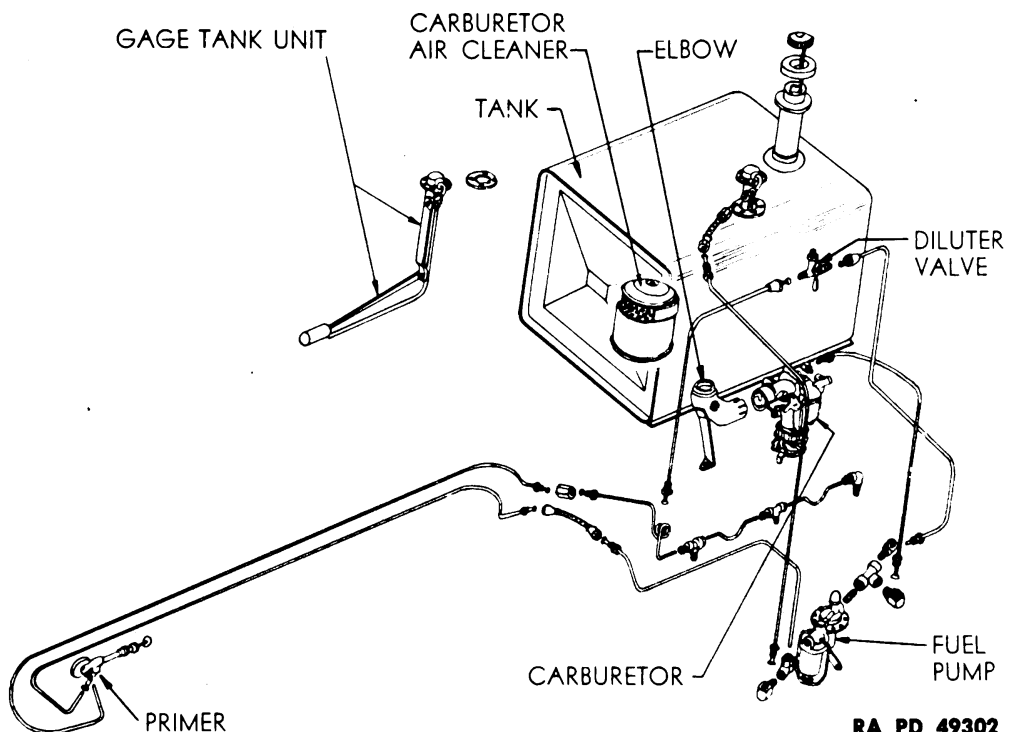

RA PD 49302

Figure 49—Fuel System Parts

**ORDNANCE MAINTENANCE — ENGINE, ENGINE ACCESSORIES,
AND CLUTCH FOR CARGO CARRIER M28 (T15)**

CHAPTER 3

FUEL SYSTEM (Cont'd)

Section II

TROUBLE SHOOTING ON FUEL SYSTEM

Trouble shooting	Paragraph 62
------------------------	-----------------

62. TROUBLE SHOOTING.

a. Excessive Fuel Consumption.

<i>Possible Cause</i>	<i>Possible Remedy</i>
Poor carburetor adjustments.	Check jet sizes against factory specifications.
Dirty air cleaner.	Clean and re-oil element.
Fuel leaks.	Check carburetor float, fuel pump diaphragm, and fuel line fittings.
Improper choke adjustment.	Inspect choke valve for full opening.

b. Fast Idling.

Carburetor throttle controls sticking.	Free controls.
Carburetor throttle improperly adjusted.	Adjust throttle stop screw and control button.

c. Low Fuel Pressure.

Fuel pump diaphragm not operating properly.	Tighten housing holding screws.
Fuel pump diaphragm porous, or torn.	Replace diaphragm.
Air leak at filter bowl.	Install new bowl gasket.
Gasoline supply line clogged.	Clean line with compressed air.

d. Lack of Fuel at Carburetor.

Empty fuel tank.	Fill tank with fuel.
Fuel pump inoperative.	Repair or replace pump.
Carburetor screen clogged.	Clean or replace screen.
Sticking carburetor float valve.	Clean or replace valve and seat.

e. Carburetor Overflowing.

Float leaking.	Replace float.
Float pin retainer clip broken.	Replace with new part.
Float valve sticking.	Clean or replace valve and seat.
Excessive fuel pump pressure.	Repair or replace.

CHAPTER 3
FUEL SYSTEM (Cont'd)

Section III

CARBURETOR

	Paragraph
Description and data	63
Removal	64
Disassembly	65
Cleaning and inspection	66
Assembly	67
Installation	68
Adjust carburetor and linkage	69

63. DESCRIPTION AND DATA.

a. Description. The carburetor used on this vehicle is a simply designed, five-circuit unit with two external adjustments; one for controlling the idle mixture, the other for controlling the idling speed. The five circuits are: the float circuit, the idle circuit, the high-speed circuit, the pump circuit, and the choke circuit.

b. Data.

Carburetor metering jets available:

- Sea level to 4,000 ft. Carter No. 159-59S
- 4,000-8,000 ft. Carter No. 159-61S
- 8,000-12,000 ft. Carter No. 159-58S
- Over 12,000 ft. Carter No. 159-66S

64. REMOVAL.

a. Raise engine compartment lid. Loosen carburetor air intake elbow clamp screw and loosen elbow support bracket which is held by a cylinder head cap screw. Move air intake elbow, support bracket, and air cleaner away from carburetor. Disconnect throttle pull back spring, choke control wire from choke adjustment collar, and conduit from bracket. Remove clevis pin to disconnect throttle control from throttle arm. Disconnect fuel pipe from carburetor. Remove nuts and lock washers that fasten carburetor to intake manifold. Lift carburetor assembly and gasket from manifold.

**ORDNANCE MAINTENANCE — ENGINE, ENGINE ACCESSORIES,
AND CLUTCH FOR CARGO CARRIER M28 (T15)**

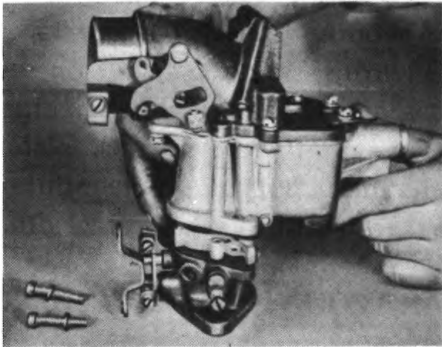

1. FLANGE ASSEMBLY REMOVAL FROM BODY CASTING

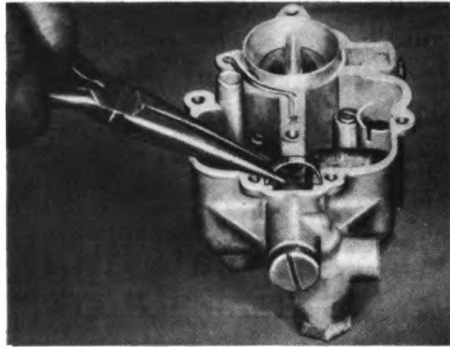

5. FLOAT PIN RETAINER SPRING REMOVAL

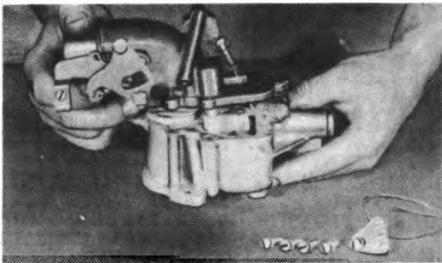

2. MAIN VENT TUBE, BOWL COVER, AND GASKET REMOVAL

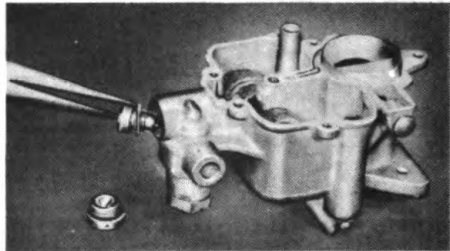

6. NEEDLE SEAT AND GASKET ASSEMBLY REMOVAL

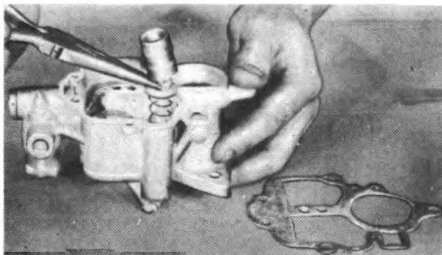

3. PUMP PLUNGER, PISTON, AND SPRING ASSEMBLY REMOVAL

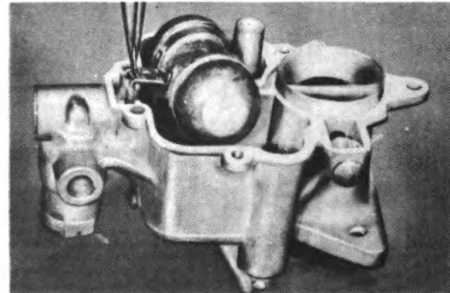

7. FLOAT ASSEMBLY AND PIN REMOVAL

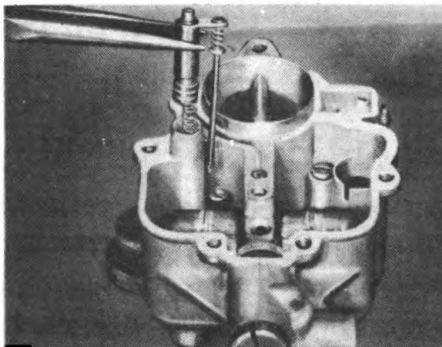

4. STEP-UP PISTON ASSEMBLY, SPRING, AND GASKET REMOVAL

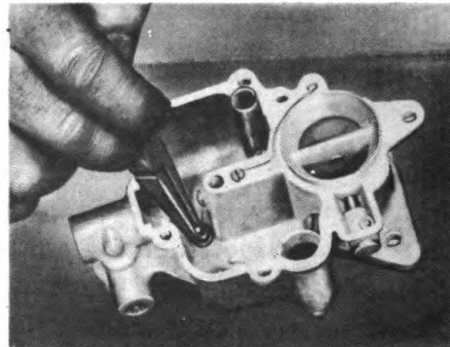

8. MAIN METERING JET AND GASKET ASSEMBLY REMOVAL

RA PD 66995

CARBURETOR

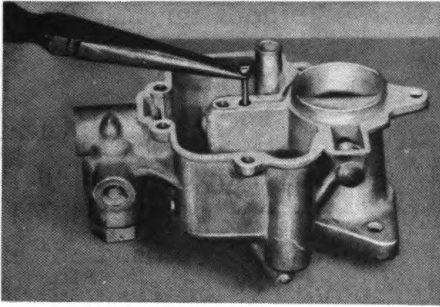

9. IDLE ORIFICE TUBE AND PLUG ASSEMBLY REMOVAL

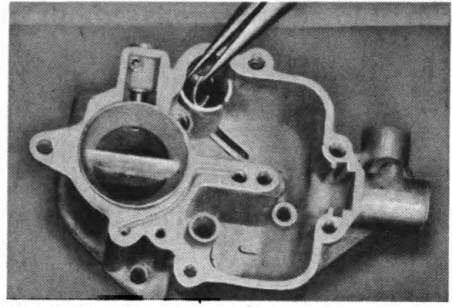

13. RETAINER RING AND INTAKE CHECK BALL REMOVAL

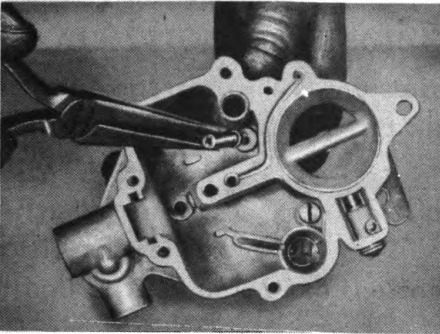

10. STEP-UP JET AND GASKET ASSEMBLY REMOVAL

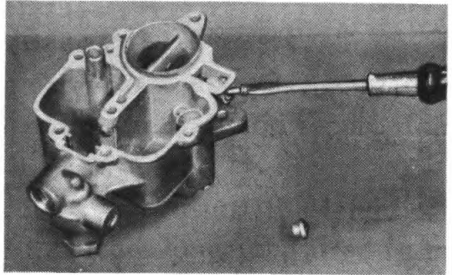

14. PUMP JET RIVET PLUG AND PUMP JET REMOVAL

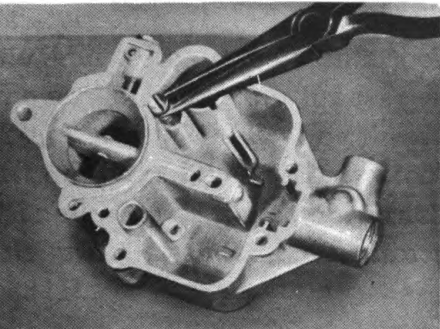

11. DISCHARGE BALL CHECK SPRING AND PLUG REMOVAL

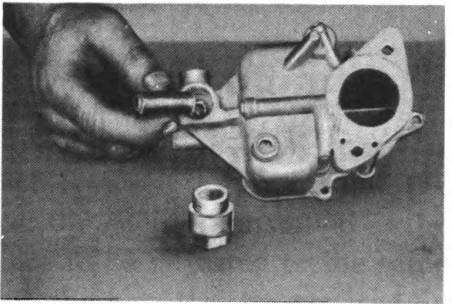

15. INLET STRAINER REMOVAL

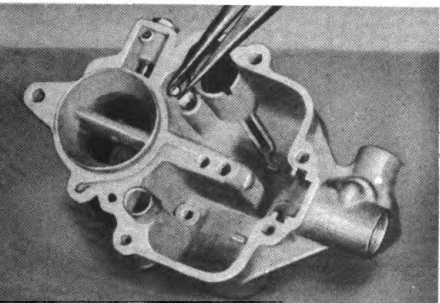

12. DISCHARGE CHECK BALL REMOVAL

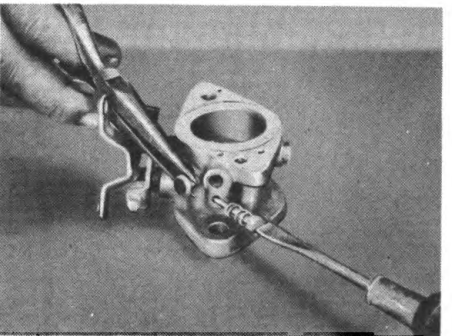

16. IDLE PORT RIVET PLUG, ADJUSTING SCREW, AND SPRING REMOVAL

RA PD 66992

Figure 51—Carburetor Disassembly (2)

**ORDNANCE MAINTENANCE — ENGINE, ENGINE ACCESSORIES,
AND CLUTCH FOR CARGO CARRIER M28 (T15)**

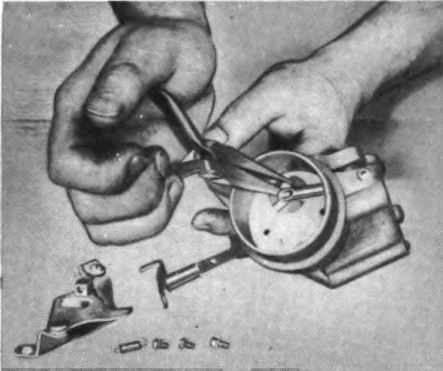

17. CHOKE VALVE AND SHAFT ASSEMBLY
REMOVAL FROM AIR HORN

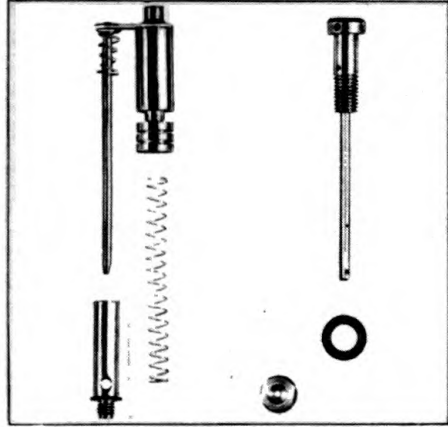

20. PARTS CONTROLLING HIGH
SPEED CIRCUIT

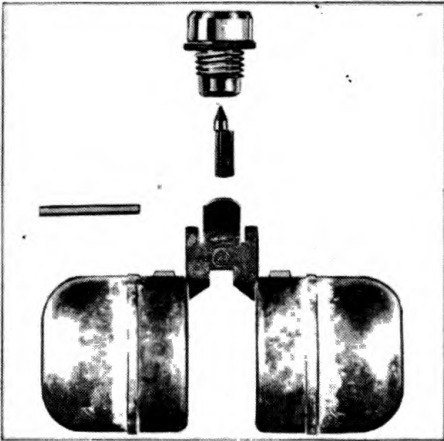

18. PARTS CONTROLLING GASOLINE LEVEL

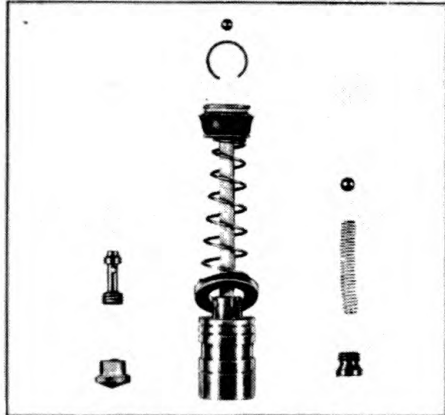

21. PARTS CONTROLLING PUMP CIRCUIT

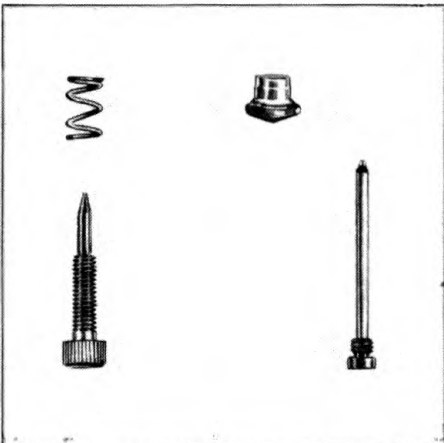

19. PARTS CONTROLLING IDLE CIRCUIT

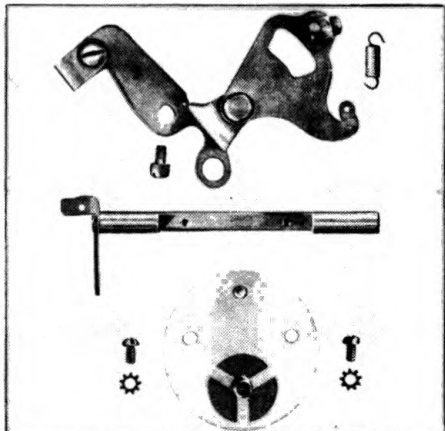

22. PARTS CONTROLLING CHOKE CIRCUIT

RA PD 66997

Figure 52—Carburetor Disassembly (3)

CARBURETOR

65. DISASSEMBLY.

a. Using Carter tool kit (41-T-3365-20), disassemble carburetor in accordance with following illustrated procedure:

- (1) Remove flange assembly from body casting (1, fig. 50).
- (2) Remove main vent tube assembly and bowl cover gasket (2, fig. 50). Slip needle seat bracket off bowl cover to facilitate removal.
- (3) Remove pump plunger, piston, and spring assembly (3, fig. 50).
- (4) Remove step-up piston assembly, spring, and gasket (4, fig. 50).
- (5) Remove horseshoe shaped float pin retainer spring (5, fig. 50).
- (6) Remove needle seat and gasket assembly (6, fig. 50).
- (7) Remove float assembly and pin (7, fig. 50).
- (8) Remove main metering jet and gasket assembly (8, fig. 50).
- (9) Remove idle orifice tube and plug assembly (9, fig. 51).
- (10) Remove step-up jet and gasket assembly (10, fig. 51).
- (11) Remove discharge ball check spring and plug (11, fig. 51).
- (12) Remove discharge ball check (12, fig. 51).
- (13) Remove retainer ring and intake check ball (13, fig. 51).
- (14) Remove pump jet rivet plug and pump jet (14, fig. 51).
- (15) Remove inlet strainer screen (15, fig. 51).
- (16) Remove idle adjusting screw, and spring, and idle port rivet plug (16, fig. 51).
- (17) Remove choke valve assembly and choke shaft assembly from air horn (17, fig. 52). Note position of levers so they can be reassembled in the same position.
- (18) Group all parts controlling gasoline level (18, fig. 52).
- (19) Group all parts controlling idle circuit (19, fig. 52).
- (20) Group all parts controlling high speed circuit (20, fig. 52).
- (21) Group all parts controlling pump circuit (21, fig. 52).
- (22) Group all parts controlling choke circuit (22, fig. 52).

66. CLEANING AND INSPECTION.

a. **Cleaning.** Place carburetor body and disassembled parts in a solution of approved carburetor cleaner or dry-cleaning solvent. Allow them to soak until any substance remaining on parts can be easily removed. Blow out all drilled passages in carburetor body and jets with compressed air.

b. **Inspection.** Inspect float circuit parts to determine if float leaks, and needle valve and seat, for evidence of grooves worn in either. Inspect idle circuit parts for visual evidence of grooves worn in point of adjusting screw, and idle speed jet for clogged passage or damage. Inspect pump circuit parts for tension of pump springs, condition of plunger, and check

**ORDNANCE MAINTENANCE — ENGINE, ENGINE ACCESSORIES,
AND CLUTCH FOR CARGO CARRIER M28 (T15)**

balls. Examine parts of choke circuit for distortion of valve, shaft, and arm. Inspect high speed circuit step-up piston and guide rod for distortion, and jets for clogged passages or damage. Inspect castings for cracks, sand holes, or damage. Replace any parts that are not satisfactory for further service.

67. ASSEMBLY.

a. During assembly, use new gaskets throughout. The assembly is made in accordance with the following illustrated procedure:

- (1) Install idle orifice tube and plug assembly (23, fig. 53).
- (2) Install new idle port rivet plug (24, fig. 53).
- (3) Install idle adjusting screw and spring (25, fig. 53). Adjust as outlined in paragraph 69 after carburetor is installed on engine.
- (4) Install pump intake check ball and retainer spring (26, fig. 53). Intake ball is the smaller of the two check balls.
- (5) Install pump plunger, spring, and piston assembly as a unit (27, fig. 53).
- (6) Install discharge check ball (28, fig. 53).
- (7) Install spring and plug (29, fig. 53).
- (8) Install pump jet (30, fig. 53).
- (9) Install new pump jet rivet plug (31, fig. 54).
- (10) Install main metering jet and gasket assembly (32, fig. 54).
- (11) Install step-up jet and gasket assembly (33, fig. 54).
- (12) Install step-up gasket, spring, and step-up piston assembly (34, fig. 54).
- (13) Install float and lever assembly in carburetor bowl and install float pin and retainer spring (35, fig. 54). Install carburetor inlet screen (refer to illustration No. 15, fig. 51).
- (14) Install needle, seat, and new gasket (36, fig. 54). Be sure bake-lite needle is not chipped.
- (15) Install float pin retainer (37, fig. 54).
- (16) Set float level (38, fig. 54). The correct float setting is $\frac{5}{64}$ inch as measured from top of bowl, to top of float, with float needle pressed firmly on its seat. To adjust, bend float lip (not the float) up, or down, to obtain proper setting.
- (17) Install bowl cover and gasket (39, fig. 55). Be sure to install needle seat bracket before installing bowl cover attaching screws.
- (18) Start bowl cover screws, then install main vent tube and plug assembly and gasket (40, fig. 55). Tighten all screws securely.

CARBURETOR

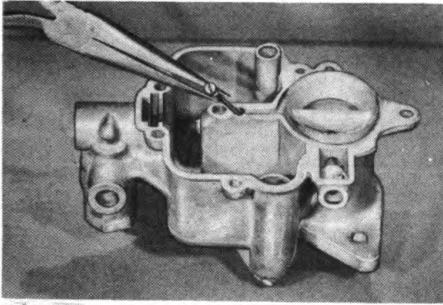

23. IDLE ORIFICE TUBE AND PLUG ASSEMBLY INSTALLATION

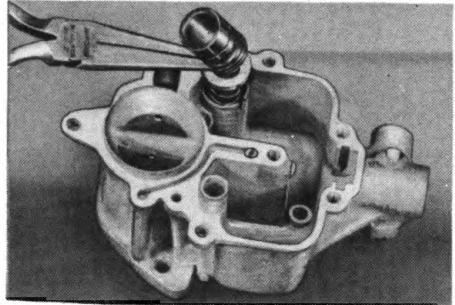

27. PUMP PLUNGER, SPRING, AND PISTON ASSEMBLY INSTALLATION

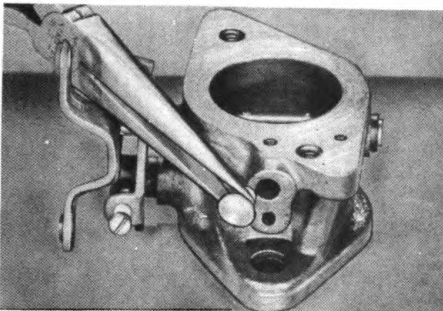

24. INSTALLING NEW IDLE PORT RIVET PLUG

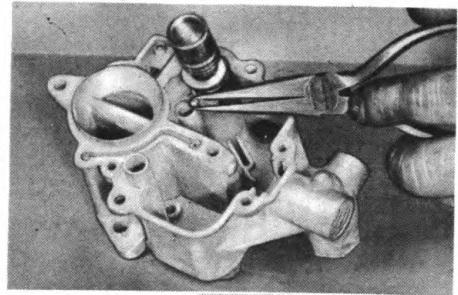

28. DISCHARGE CHECK BALL INSTALLATION

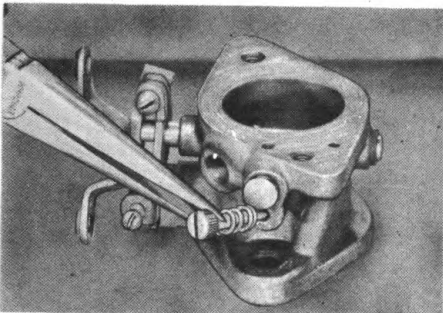

25. IDLE ADJUSTING SCREW AND SPRING INSTALLATION

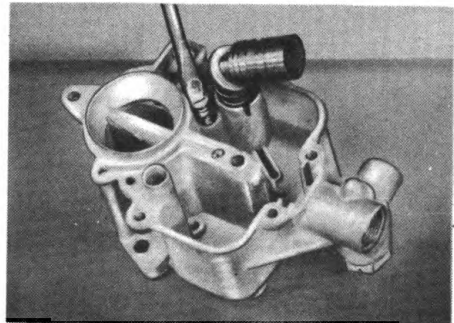

29. DISCHARGE SPRING AND PLUG INSTALLATION

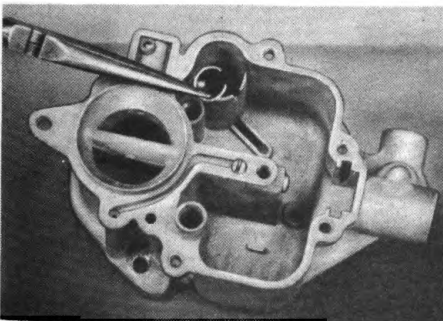

26. PUMP INTAKE CHECK BALL AND RETAINER INSTALLATION

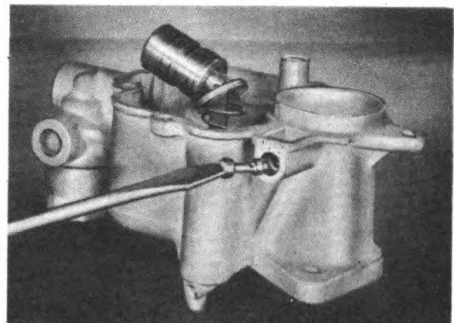

30. PUMP JET INSTALLATION

RA PD 66994

Figure 53—Carburetor Assembly (4)

**ORDNANCE MAINTENANCE — ENGINE, ENGINE ACCESSORIES,
AND CLUTCH FOR CARGO CARRIER M28 (T15)**

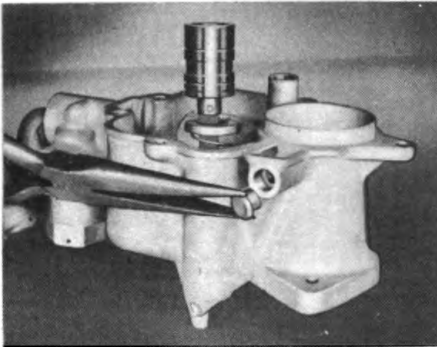

31. INSTALLING NEW PUMP JET RIVET PLUG

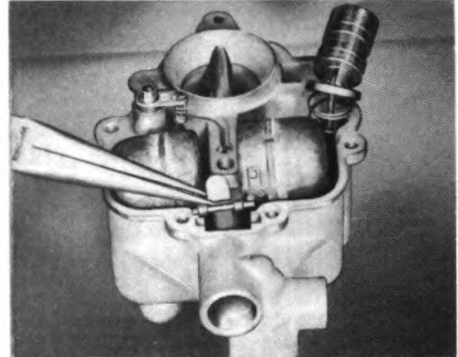

35. FLOAT ASSEMBLY AND PIN INSTALLATION

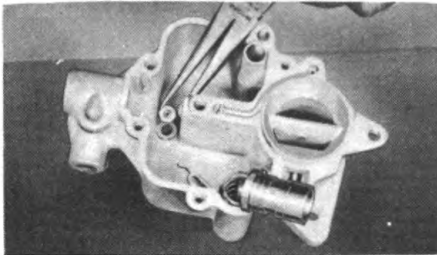

32. MAIN METERING JET AND GASKET INSTALLATION

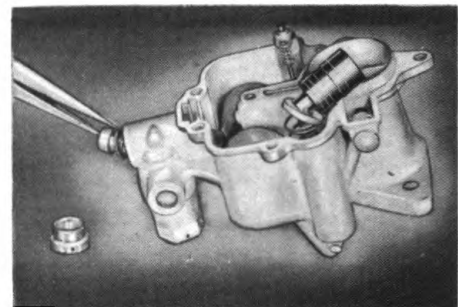

36. NEEDLE, SEAT, AND GASKET ASSEMBLY INSTALLATION

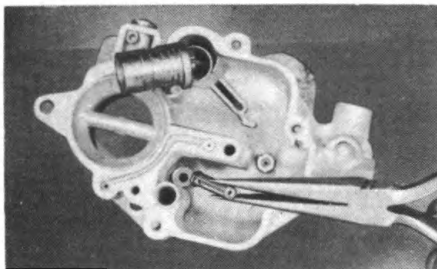

33. STEP-UP JET AND GASKET ASSEMBLY INSTALLATION

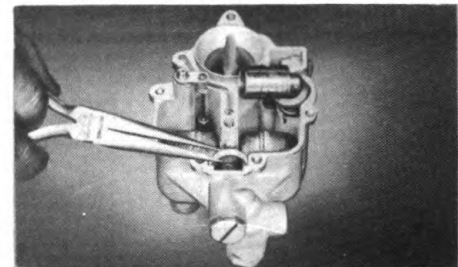

37. FLOAT PIN RETAINER INSTALLATION

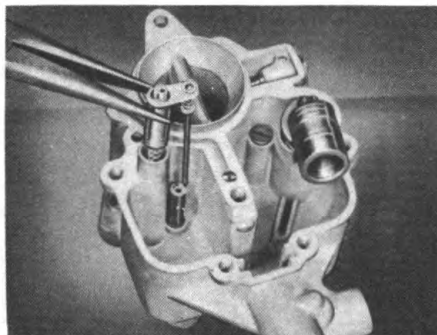

34. GASKET, SPRING, AND STEP-UP PISTON ASSEMBLY INSTALLATION

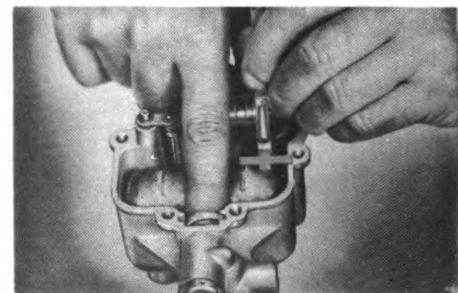

38. SETTING FLOAT LEVEL

RA PD 66996

Figure 54—Carburetor Assembly (5)

CARBURETOR

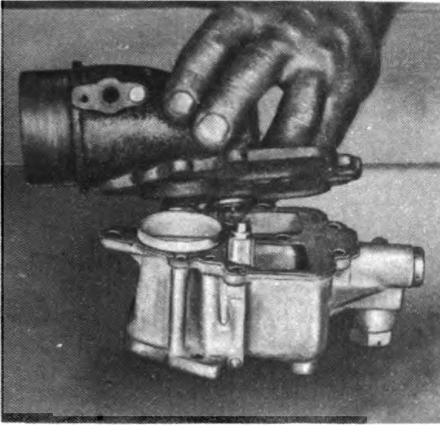

39. BOWL COVER AND GASKET
INSTALLATION

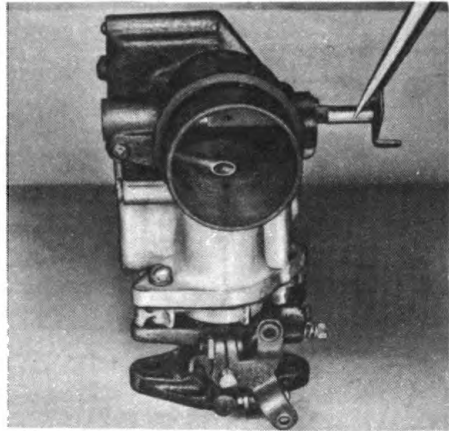

42. CHOKE SHAFT, SPRING, AND
LEVER INSTALLATION

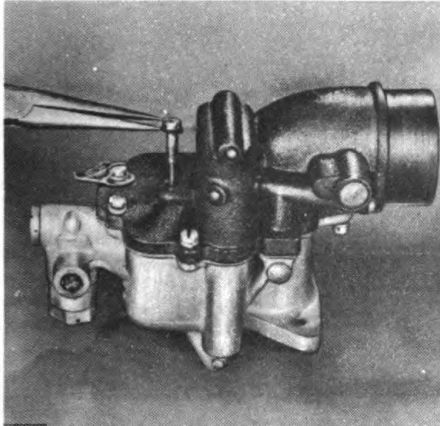

40. FLOAT CHAMBER COVER AND MAIN
VENT TUBE INSTALLATION

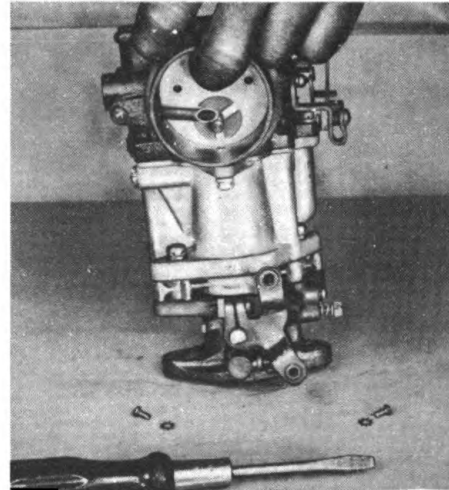

43. CHOKE VALVE INSTALLATION

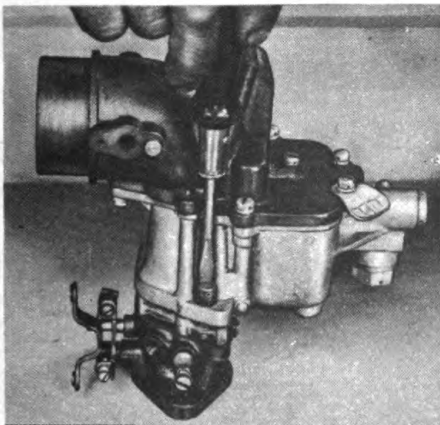

41. ATTACHING FLANGE TO BODY

RA PD 66993

Figure 55—Carburetor Assembly (6)

**ORDNANCE MAINTENANCE — ENGINE, ENGINE ACCESSORIES,
AND CLUTCH FOR CARGO CARRIER M28 (T15)**

(19) Attach flange assembly, insulator, and gaskets to body (41, fig. 55).

(20) Install choke shaft, spring, and levers (42, fig. 55).

(21) Install choke valve (43, fig. 55). Relief valve must be to the bottom, and away from incoming air. Always use new screws including toothed lock washers under heads of screws.

68. INSTALLATION.

a. Place a new gasket in position on manifold and set carburetor on gasket. Install lock washers and tighten nuts securely. Connect fuel pipe line to carburetor. Connect choke control wire to choke arm, fasten con-

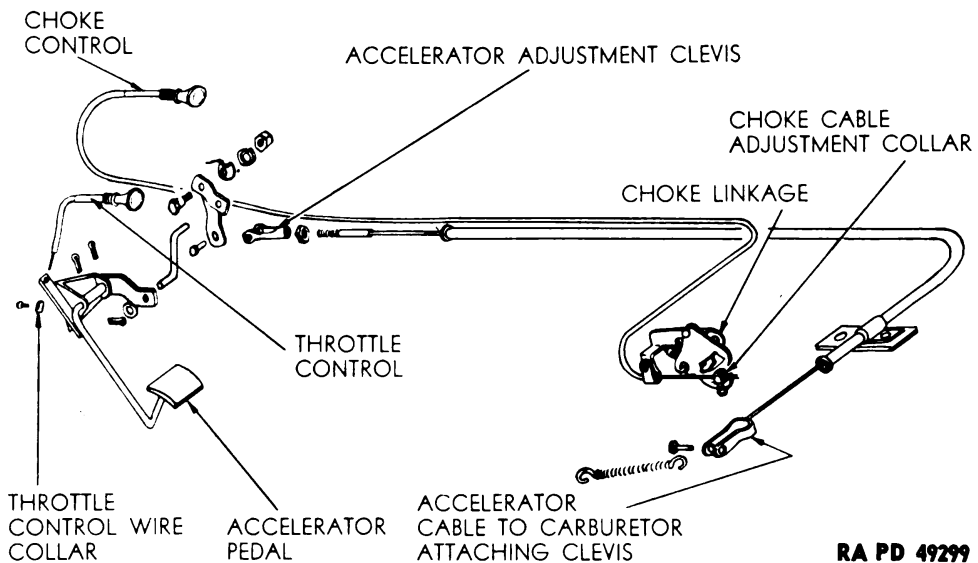

Figure 56—Carburetor Controls and Linkage

duit to bracket, and tighten lock screw. Connect throttle control clevis to throttle operating arm with clevis pin and hook pull back spring on clevis pin. Place carburetor air intake elbow over carburetor intake and tighten clamp screw securely. Tighten cylinder head screw holding elbow support bracket to the proper tension. Adjust carburetor and linkage (par. 69) and lower engine compartment lid.

69. ADJUST CARBURETOR AND LINKAGE.

a. **Idling Adjustment.** Operate engine until heat indicator on instrument panel registers 175 (normal operating temperature). Turn throttle stop screw clockwise to increase idle speed, and counterclockwise to decrease idling speed, of engine (fig. 57). Adjust idle mixture by turning adjusting screw, in or out, to obtain smoothest idle performance (fig. 58).

CARBURETOR

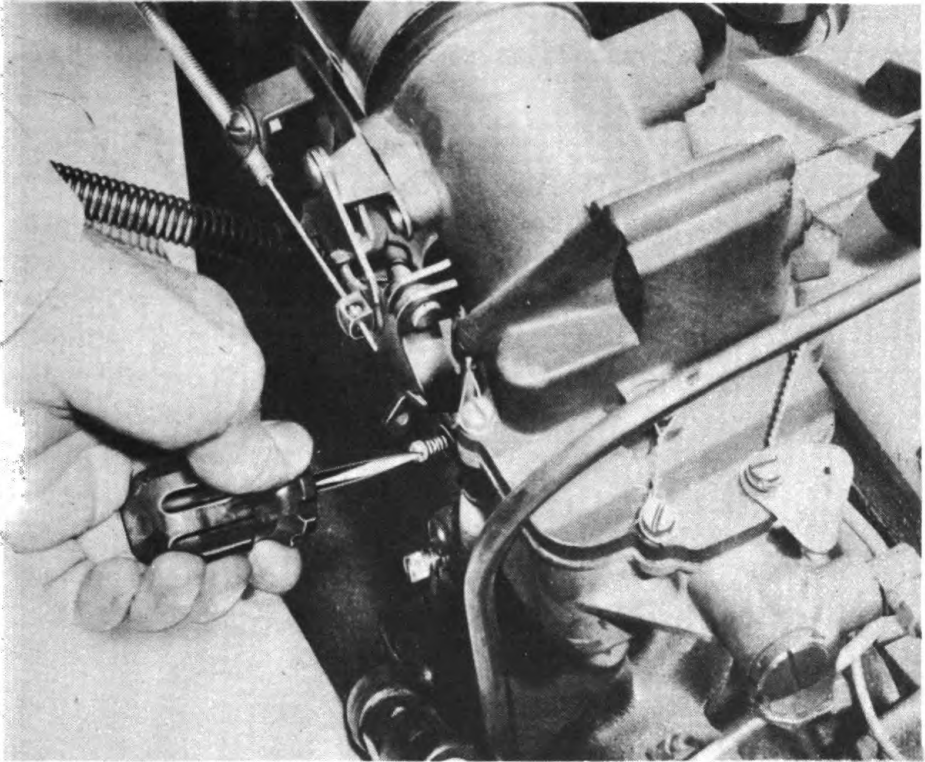

RA PD 49356

Figure 57—Adjusting Carburetor Throttle Stop Screw

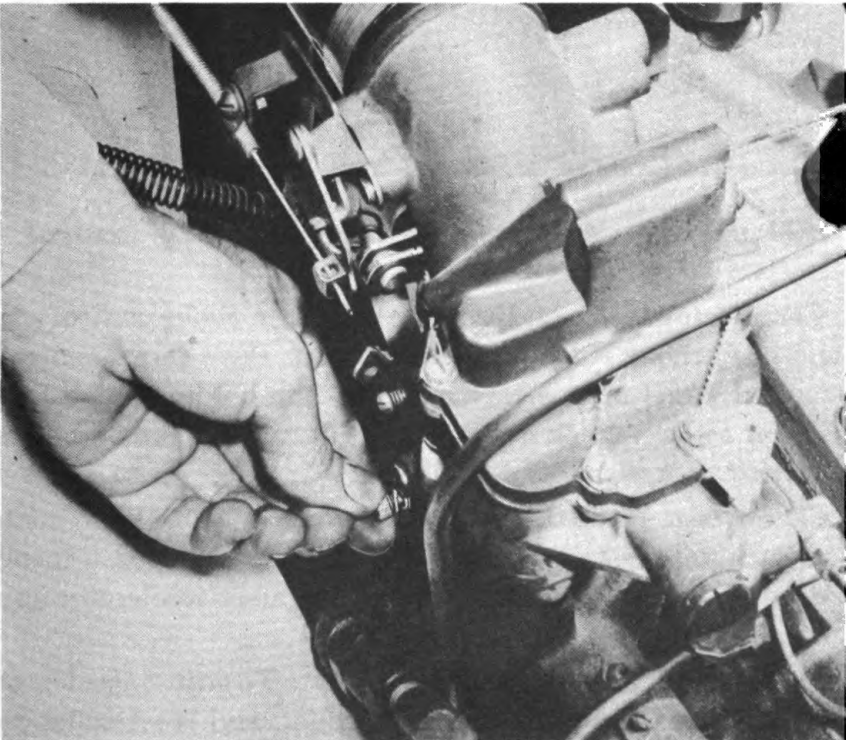

RA PD 49357

**ORDNANCE MAINTENANCE — ENGINE, ENGINE ACCESSORIES,
AND CLUTCH FOR CARGO CARRIER M28 (T15)**

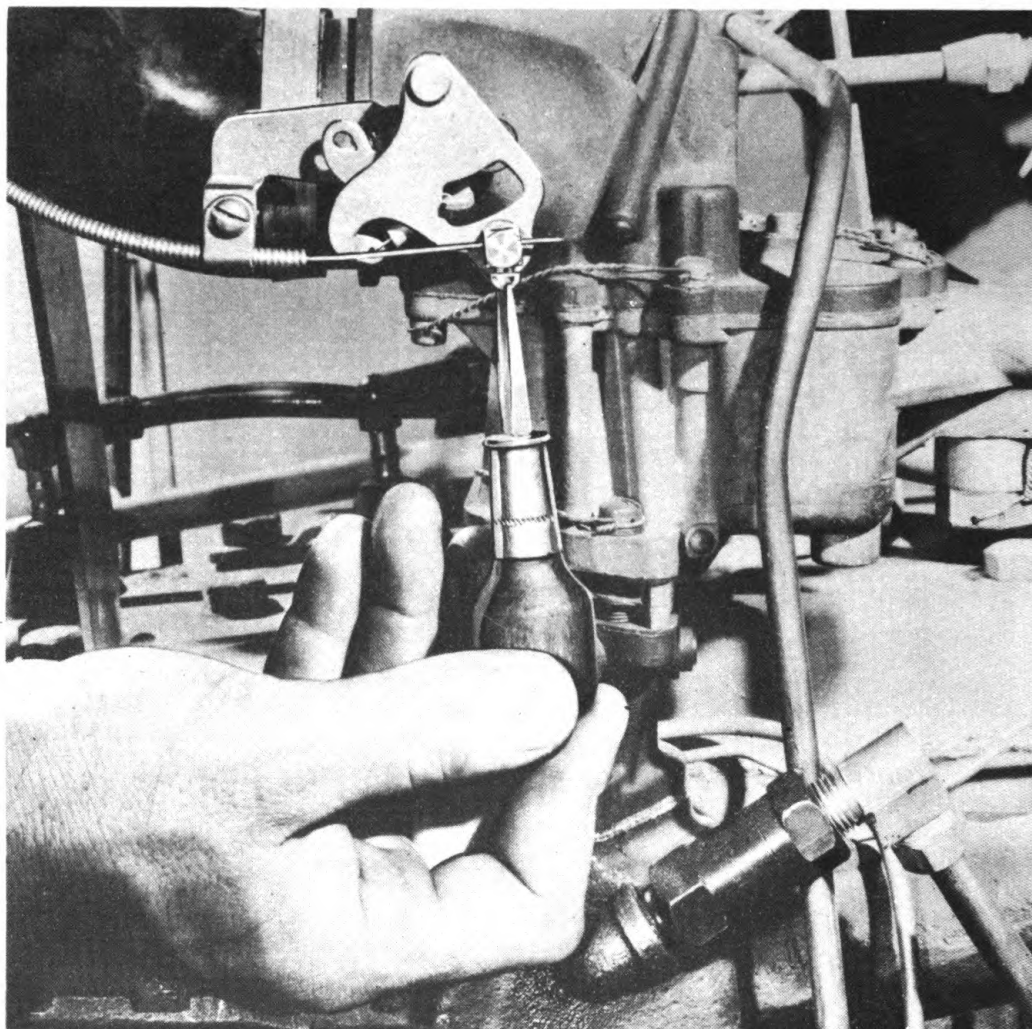

RA PD 49401

Figure 59—Adjusting Carburetor Choke Control

b. Carburetor Choke Adjustment. Loosen choke control wire collar screw and push choke valve all the way open. Push choke control button on instrument panel all the way in, and while holding valve fully open, tighten collar screw to lock control wire (fig. 59). Open and close choke valve to check operation.

c. Carburetor Hand Throttle Adjustment. With hand control button in fully closed position against instrument panel, loosen throttle control wire screw, then hold control wire collar against accelerator upper arm, and tighten screw.

d. Carburetor Accelerator Adjustment. To adjust accelerator throttle linkage, loosen throttle control wire collar, and reset collar to assure full throttle closing at throttle stop screw on throttle shaft operating arm of carburetor. If throttle valve does not open completely, as indicated by

CARBURETOR

fixed stop on throttle shaft operating arm, with accelerator fully depressed, loosen throttle control wire collar. Loosen accelerator clevis lock nut and remove accelerator cable cotter pin and clevis pin. Turn clevis to change effective length of cable to provide pedal travel required for full throttle opening. Install clevis pin, new cotter pin, and tighten clevis lock nut. Reset throttle control wire collar to obtain proper closed throttle idle position. Check linkage to make sure that with accelerator pedal fully depressed, throttle valve fixed stop on operating arm contacts boss on carburetor, then, when accelerator pedal is fully released, throttle stop screw fully contacts boss on carburetor.

ORDNANCE MAINTENANCE — ENGINE, ENGINE ACCESSORIES,
AND CLUTCH FOR CARGO CARRIER M28 (T15)

CHAPTER 3

FUEL SYSTEM (Cont'd)

Section IV

FUEL PUMP

	Paragraph
Description and data.....	70
Removal	71
Disassembly	72
Cleaning	73
Inspection	74
Assembly	75
Testing	76
Installation	77

70. DESCRIPTION AND DATA.

a. **Description.** A diaphragm-type fuel pump (fig. 60) is attached to the cylinder block on the manifold side. The pump is mechanically operated by means of a rocker arm which contacts a lobe on camshaft. It contains a strainer screen and metal sediment bowl. An external lever is provided on the pump to fill manually the fuel pump bowl and float chamber in carburetor. The lever is directly below pump body.

b. **Data.**

MakeAC
Type.....Diaphragm, mechanically operated

71. REMOVAL.

a. Remove engine (par. 7). Disconnect inlet and outlet pipes from fuel pump. Remove cap screws holding fuel pump to cylinder block, remove fuel pump and gasket (fig. 61).

72. DISASSEMBLY.

a. Remove pump chamber cover screws and remove cover from pump body (fig. 62). Remove diaphragm assembly from rocker arm by holding rocker arm outer end down, push diaphragm assembly downward, unhook pull rod from inner end of rocker arm and remove diaphragm assembly.

FUEL PUMP

RA PD 66953

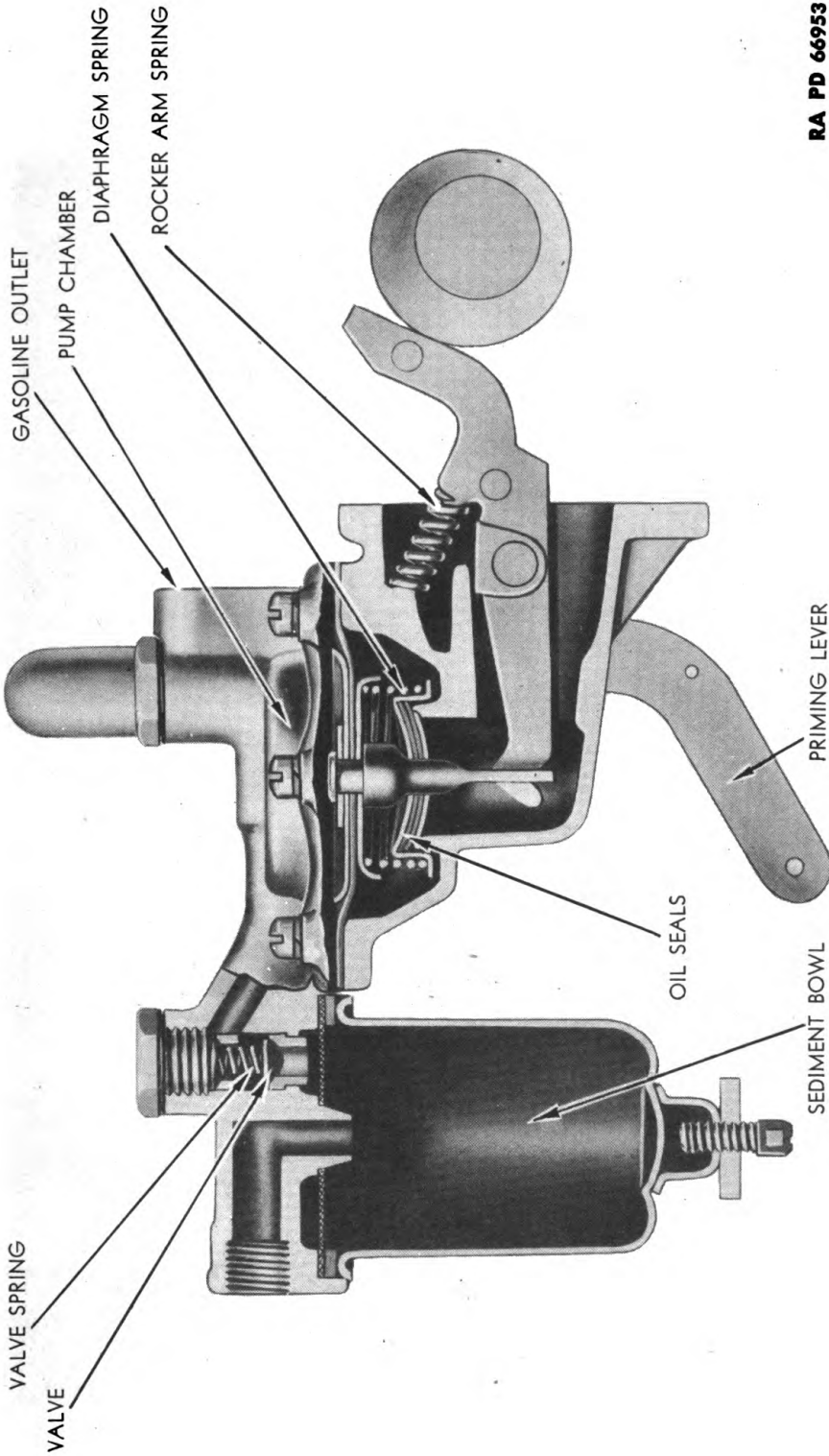
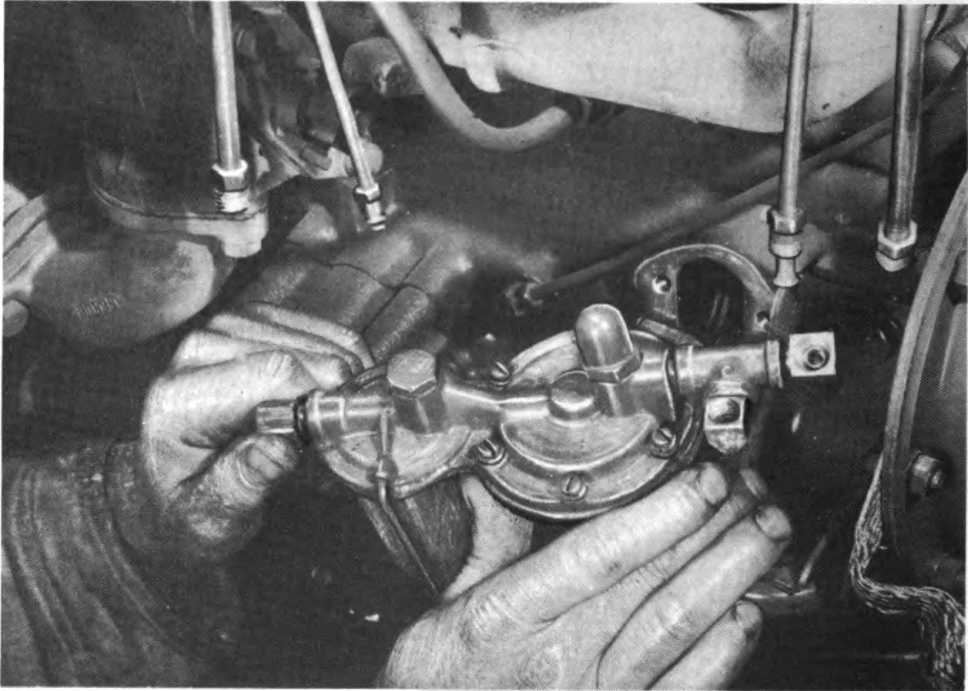

Figure 60—Fuel Pump Cross Section

**ORDNANCE MAINTENANCE — ENGINE, ENGINE ACCESSORIES,
AND CLUTCH FOR CARGO CARRIER M28 (T15)**



RA PD 309982

Figure 61—Removing Fuel Pump

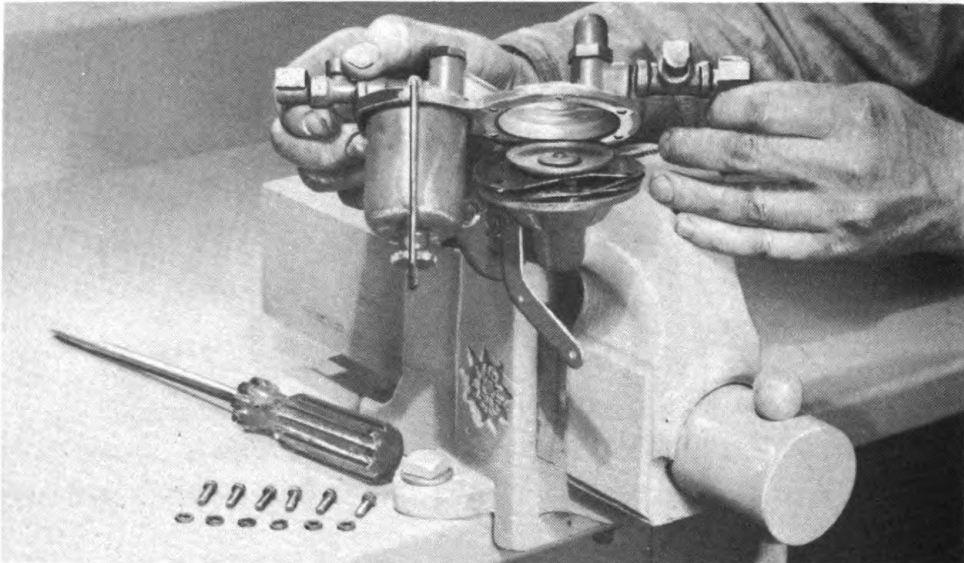

RA PD 309981

Figure 62—Removing Fuel Pump Top Cover

FUEL PUMP



RA PD 66943

Figure 63—Removing Fuel Pump Anchor Pin and Arm

Take rocker arm pin out of arm (fig. 63); remove rocker arm and return spring. Remove sediment bowl by unscrewing bowl seat nut at bottom and remove the sediment bowl, screen, and gasket. Remove the intake and air dome plugs, tension springs, and fiber washers (fig. 64).

73. CLEANING.

a. Clean sediment bowl thoroughly and dry with a clean cloth. Clean strainer screen thoroughly in dry-cleaning solvent. Blow through strainer

FUEL PUMP



RA PD 66942

Figure 65—Assembling Diaphragm Parts

**ORDNANCE MAINTENANCE — ENGINE, ENGINE ACCESSORIES,
AND CLUTCH FOR CARGO CARRIER M28 (T15)**

screen with compressed air to complete cleaning operation. Immerse all other metal parts in dry-cleaning solvent, clean thoroughly, and dry with compressed air.

74. INSPECTION.

a. If rocker arm assembly is found to be excessively loose at pivot pin or linkage, replace it. Inspect diaphragm assembly for cracks or damage, and replace if not satisfactory for further service. Replace oil seals every time fuel pump is disassembled. Examine all other parts for breakage or other damage, and replace any parts that are not satisfactory for further service.

75. ASSEMBLY.

a. Install rocker arm spring and rocker arm in fuel pump body and install rocker arm pin. Assemble oil seal retainer, oil seals, diaphragm spring seat, and diaphragm spring to diaphragm pull rod. Install diaphragm assembly to rocker arm by holding arm outer end down, push diaphragm assembly downward, and hook diaphragm pull rod on inner end of arm (fig. 65). Install chamber cover to pump body by holding diaphragm flush with pump body. Insert the screws and tighten securely. Place valve and valve spring in position. Install a new gasket and plug. Place a new gasket on pump chamber cover and install air dome. Install sediment bowl screen, new gasket, bowl, and tighten securely.

76. TESTING.

a. Before installing fuel pump to cylinder block, make a bench test. Close both inlet and outlet openings. Operate rocker arm and note results. A fuel pump pressure of 2 to 4 pounds should register on a test gage. Test for leaks between diaphragm, cover, and body.

77. INSTALLATION.

a. **Install Fuel Pump.** Turn crankshaft until high side of camshaft lobe is away from pump mounting surface on cylinder block. Install new gasket to pump housing and insert cap screws with lock washers through pump flange. Place pump flange against mounting surface on cylinder block so that the lower side of rocker arm contacts lobe on camshaft, then tighten screws securely. Connect pipes to fuel pump and tighten securely. Install engine (par. 58).

CHAPTER 3
FUEL SYSTEM (Cont'd)

Section V

FUEL TANK

	Paragraph
Description	78
Removal	79
Disassembly	80
Cleaning	81
Inspection	82
Assembly	83
Installation	84

78. DESCRIPTION.

a. The 25-gallon fuel tank is located to the right of the engine and held in position by two band clamps. A large filler neck having a sealed type cap to prevent fuel loss when vehicle is being operated at extreme angles, extends up through the engine compartment lid. The fuel gage tank unit is attached to the top of the tank near the left center.

79. REMOVAL.

a. Remove engine compartment front lid screen and engine compartment lid with hinge (par. 7 d). Remove battery compartment cover and disconnect battery ground strap (par. 7 h). Remove radiator (par. 118 b). Loosen tank filler cap, disconnect tank to fuel pump pipe flexible coupling from gage tank unit, and disconnect gage wire from tank unit terminal. Disconnect the rear marker light wire from connector, remove two wire harness clips from right coaming, and move harness away from top of tank. Remove current and voltage regulator from bulkhead with wires attached and place regulator out of the way.

b. Disconnect oil filter inlet and outlet pipes from filter fittings and remove filter from bracket. Remove generator adjusting arm cap screw and loosen adjusting arm pivot stud so that the arm can be moved out of the way. Remove gas tank strap clamp bolts, nuts, and washers. Bend left straps down flat, move tank forward and to left. Raise left side and carefully lift tank out of engine compartment (fig. 66).

80. DISASSEMBLY.

a. Remove screws and copper asbestos washers, that fasten fuel gage tank unit to top of tank, and remove unit and gasket from tank. Drain all fuel from tank.

**ORDNANCE MAINTENANCE — ENGINE, ENGINE ACCESSORIES,
AND CLUTCH FOR CARGO CARRIER M28 (T15)**

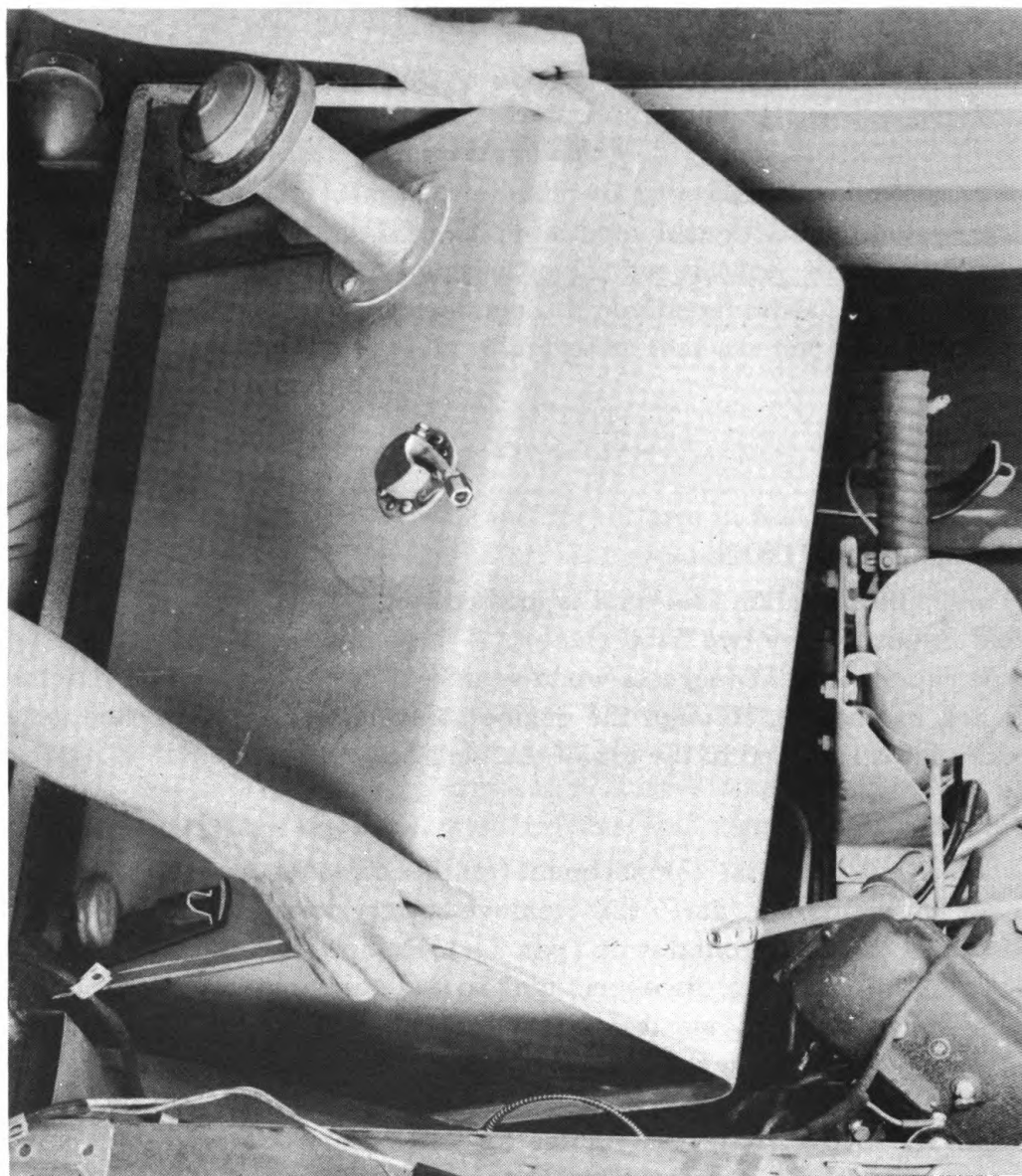

RA PD 49309

Figure 66—Removing Fuel Tank

81. CLEANING.

a. When cleaning inside of fuel tank, use steam and hot water to remove all dirt and rust. Rinse inside of tank with dry-cleaning solvent to complete cleaning operation. Clean outside of tank thoroughly with dry-cleaning solvent.

82. INSPECTION.

a. Inspect fuel tank for leaks or damage, and repair or replace.

FUEL TANK

83. ASSEMBLY.

a. Place a new gage tank unit gasket on tank, insert unit float into opening in tank, install screws with new copper asbestos gaskets, and tighten securely.

84. INSTALLATION.

a. Apply grease to band surfaces on which tank rests to facilitate sliding tank into position. Carefully slide tank into position and tighten band clamps securely. Install generator adjusting arm cap screw, adjust tension of fan belt (par. 126), and tighten cap screw and arm pivot stud securely. Install oil filter on bracket and connect inlet and outlet pipes to filter fittings. Place current and voltage regulator in position on bulkhead and fasten securely with toothed lock washers between regulator legs and bulkhead.

b. Fasten wiring harness to coaming with clips and connect rear marker light wire to connector. Connect fuel gage wire to terminal on tank unit, and fuel pump to tank pipe flexible coupling, to tank unit. Install radiator (par. 58). Connect battery ground strap and install battery compartment cover (par. 58). Install engine compartment lid with hinge, and engine compartment front lid screen (par. 58). Fill cooling system to proper level. Fill fuel tank with gasoline, start engine, and check for leakage.

ORDNANCE MAINTENANCE — ENGINE, ENGINE ACCESSORIES,
AND CLUTCH FOR CARGO CARRIER M28 (T15)

CHAPTER 3
FUEL SYSTEM (Cont'd)

Section VI

PRIMER

	Paragraph
Description	85
Removal	86
Inspection	87
Test	88
Installation	89

85. DESCRIPTION.

a. The primer circuit consists of a hand-operated pump with a system of inlet and outlet pipes. The pump handle is located near the lower right corner of instrument panel. When pump handle is pulled outward the piston draws a charge of fuel into the cylinder. When the piston is pushed in, the charge is distributed through the outlet pipe to three connections on the intake manifold. It is not probable that the primer will require special service other than to keep the connections tight.

86. REMOVAL.

a. Disconnect inlet pipe coupling and outlet pipe from primer. Remove primer operating button from face of instrument panel by turning counterclockwise while holding flat side of pump shaft. Loosen lock nut behind panel face and remove escutcheon nut from panel face, then slip primer out of panel. If it is necessary to remove primer pipes, removal procedure will depend on pipe or pipes to be removed; however, no special instructions are needed.

87. INSPECTION.

a. Inspect primer for breakage or damage, and replace if not satisfactory for further service. Replace any pipes, couplings, or fittings that are broken or damaged.

88. TEST.

a. Place primer inlet fitting in a pan, or bucket, containing fuel, and pull primer handle outward to draw a charge of fuel into cylinder. Push handle in while observing if fuel is forced out of the primer outlet fitting.

PRIMER

89. INSTALLATION.

a. Place primer into position on panel; install lock nut behind panel face but do not tighten. Install escutcheon nut on panel face and then tighten lock nut. Connect outlet and inlet pipes to primer and make sure that all couplings are tight and no leakage exists. A very slight leak in system will render primer ineffective.



Section VII

FITS AND TOLERANCES

Paragraph

Fuel system service data 90

90. FUEL SYSTEM SERVICE DATA.

a. Fuel Pump.

Pressure 2 to 4 lb

b. Carburetor.

Float setting $\frac{5}{64}$ in. from top of bowl to top of float
with float needle against seat

Idle mixture setting $\frac{1}{4}$ to $1\frac{1}{4}$ turns open

ORDNANCE MAINTENANCE — ENGINE, ENGINE ACCESSORIES,
AND CLUTCH FOR CARGO CARRIER M28 (T15)

CHAPTER 4

MANIFOLD AND EXHAUST SYSTEM

Section I

DESCRIPTION AND DATA

	Paragraph
Description	91
Data	92

91. DESCRIPTION.

a. The one-piece manifold is made of cast-iron and incorporates a heat control valve. Two exhaust pipes and an elbow are used to carry the exhaust from the manifold exhaust outlet to the muffler, which is mounted on the left rear deck.

92. DATA.

Manifold	One-piece
Heat control valve	Automatic
Exhaust line	Three-piece
Muffler	Straight through

Section II

TROUBLE SHOOTING

	Paragraph
Trouble shooting	93

93. TROUBLE SHOOTING.

a. Exhaust Leaks.

Possible Cause	Possible Remedy
Manifold gaskets burned.	Replace gaskets.
Manifold cracked.	Repair or replace.
Exhaust pipe flange gaskets burned.	Replace gaskets.
Exhaust pipe burned or rusted through.	Replace pipe.

TROUBLE SHOOTING

b. Engine Lacks Power.

Possible Cause	Possible Remedy
Manifold heat control valve shaft stuck.	Free valve shaft.
Exhaust pipe or muffler partially clogged.	Remove restriction or replace as required.

Section III

MANIFOLD

	Paragraph
Description	94
Removal	95
Disassembly	96
Cleaning	97
Inspection	98
Assembly	99
Installation	100

94. DESCRIPTION.

a. The one-piece manifold incorporates a heat control valve which shunts the exhaust gases around the center section of the intake manifold to preheat the fuel mixture before it enters the combustion chambers.

95. REMOVAL.

a. Remove engine (par. 7). Disconnect fuel line from fitting on carburetor, remove nuts holding carburetor to intake manifold, and lift off carburetor with gasket. Remove primer outlet pipe from fitting in manifold. Disconnect and remove ventilation pipe from manifold and valve cover. Remove nuts and clamps holding manifold to cylinder block. Remove manifold and gasket from block.

96. DISASSEMBLY.

a. Remove nuts holding elbow to manifold and lift elbow and gasket from manifold. Disconnect primer pipes and remove fittings from manifold. Take out cap screws that hold heat control valve assembly (fig. 67) to manifold; remove valve assembly and gasket. Remove set screw from valve counterweight, pull weight off end of shaft, slip thermostatic spring off, and remove shaft from cover.

**ORDNANCE MAINTENANCE — ENGINE, ENGINE ACCESSORIES,
AND CLUTCH FOR CARGO CARRIER M28 (T15)**

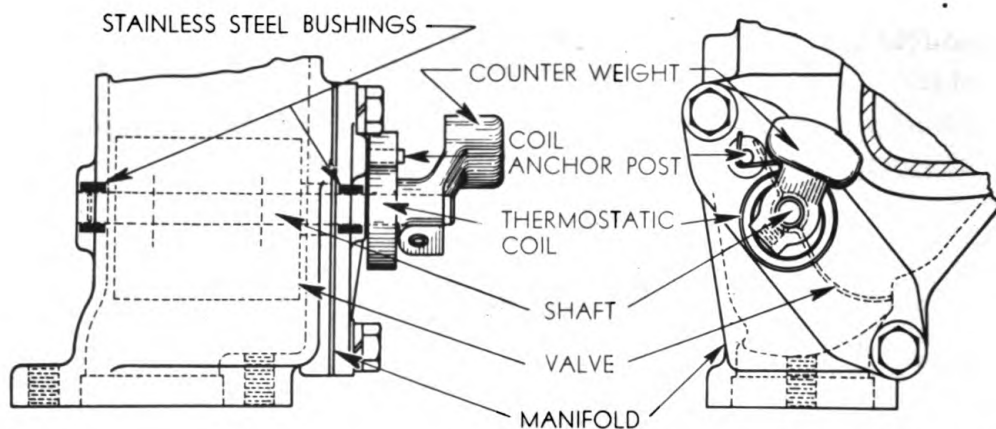

RA PD 49339

Figure 67—Manifold Heater Valve Construction

97. CLEANING.

a. Clean all parts thoroughly with dry-cleaning solvent and dry with compressed air. Use a putty knife to remove any carbon formations, pieces of gaskets, or other foreign substance.

98. INSPECTION.

a. Inspect manifold and elbow for cracks, sand holes, or other damage. Examine primer pipes for damage and connections for stripped threads. Inspect heat control valve cover and shaft for breakage or other damage. Examine shaft counterweight and thermostatic spring for breakage. If manifold and elbow cannot be placed in a serviceable condition, replace them. Replace any primer pipes or fittings that are not satisfactory for further service. If heat control valve and cover are broken, replace them. Machine bearing surfaces of heat control valve shaft to make certain it will operate freely in bearings. Replace shaft counterweight if it is broken, and thermostatic spring, if it is rusted or burned so that life is gone from metal.

99. ASSEMBLY.

a. Insert split end of heat control valve shaft (with valve attached) through cover. Place thermostatic spring in position on shaft and hook end of spring on pin located in cover. Install a new heat control cover gasket on manifold, and insert other end of valve shaft through opening in manifold, and enter shaft in bearing in front side of manifold. Install cap screws, lock washers, and tighten securely. With heater valve held in the closed position by thermostatic spring, place counterweight on valve

MANIFOLD

shaft so set screw is near bottom and alined with slot in shaft. The counterweight should not be slid on shaft too far, as it will restrict the end play of shaft.

b. Install primer pipe fittings in manifold and connect primer pipes to fittings. Place a new manifold to elbow gasket on manifold, set elbow on gasket, install nuts on studs, and tighten securely.

100. INSTALLATION.

a. Place a new manifold to block gasket against cylinder block so that raised rings are away from block. Place manifold in position over studs and against gasket, install retaining clamps, and tighten nuts securely. Install ventilation pipe to manifold and valve cover fittings and tighten connections securely. Connect primer outlet pipe to fitting at front of manifold. Install a new gasket on intake manifold flange, set carburetor on gasket, and tighten securely with nuts. Connect fuel line to fitting on carburetor. Install engine (par. 58).

Section IV

EXHAUST PIPES AND MUFFLER

	Paragraph
Description	101
Removal	102
Inspection	103
Installation	104

101. DESCRIPTION.

a. The exhaust system consists of two exhaust pipes, an elbow, and a muffler. The lower exhaust pipe is flanged at one end for attachment to the manifold elbow. The upper exhaust pipe has a flexible section between two tubular sections. The muffler is mounted on the left rear deck of vehicle and is protected with a wire mesh guard.

102. REMOVAL.

a. **Remove Muffler.** Take out bolts and nuts holding muffler guard in position and remove the guard, Remove cap screws holding muffler clamps to deck. Loosen muffler front clamp bolt and nut, pull muffler off pipe, and remove from vehicle. Loosen muffler rear clamp bolt and nut and remove clamp from muffler.

b. **Remove Upper Exhaust Pipe.** Raise engine compartment lid and remove engine compartment front lid screen (par. 7). Remove metal screws that secure exhaust pipe to hull gasket retainer to coaming. Loosen

**ORDNANCE MAINTENANCE — ENGINE, ENGINE ACCESSORIES,
AND CLUTCH FOR CARGO CARRIER M28 (T15)**

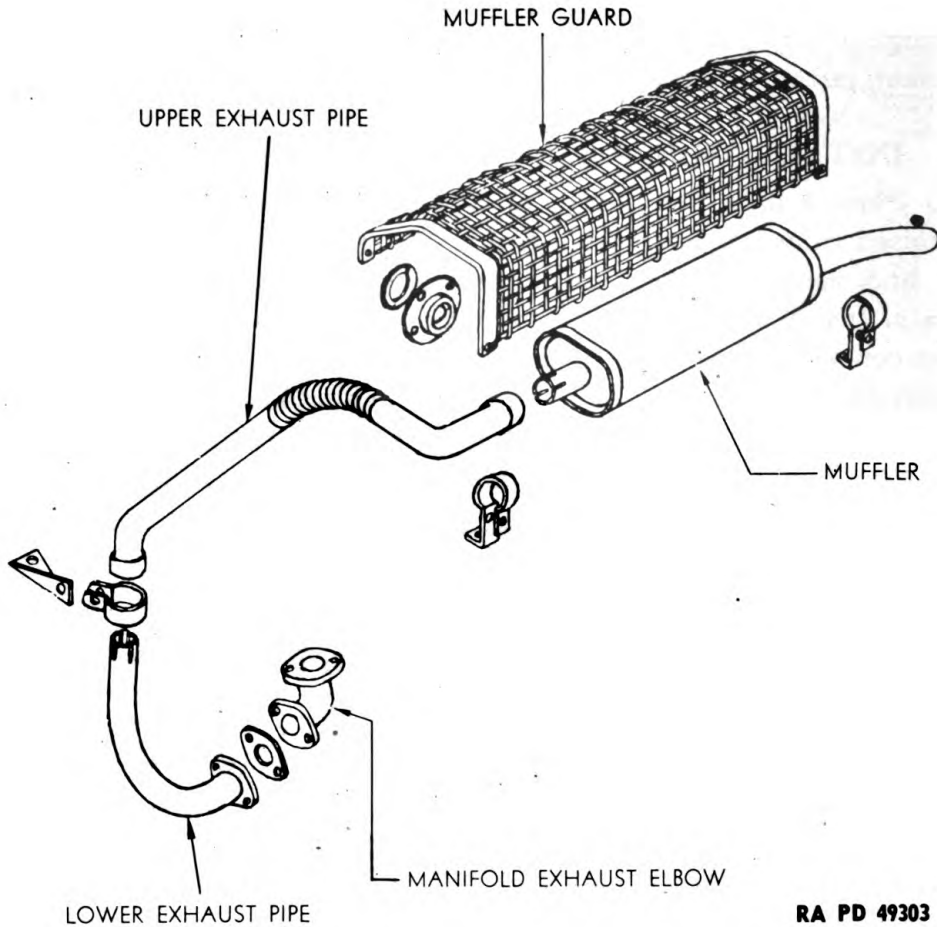

RA PD 49303

Figure 68—Exhaust System Parts

clamp holding upper and lower exhaust pipe sections together and remove upper pipe.

c. Remove Lower Exhaust Pipe and Elbow. Take out bolts and nuts that attach lower exhaust pipe flange to manifold elbow. Remove pipe and gasket. Take off nuts holding exhaust pipe elbow to manifold and remove elbow and gasket.

103. INSPECTION.

a. Inspect exhaust pipes, elbow, and muffler for a rusted, or burned through, condition, and damage. Replace parts that are not satisfactory for further service.

EXHAUST PIPES AND MUFFLER

104. INSTALLATION.

a. Install Lower Exhaust Pipe and Elbow. Install a new gasket on manifold flange, place elbow in position against gasket and install and tighten nuts securely. Place a new gasket on elbow flange and insert upper end of lower pipe into clamp held in position by a cylinder head cap screw. Hold lower pipe flange against elbow gasket, install bolts and nuts, and tighten securely.

b. Install Upper Exhaust Pipe. Insert upper end of upper exhaust pipe through hole in coaming. Place lower end of upper pipe into clamp and over upper end of lower pipe. Tighten clamp bolt and nut to hold upper and lower exhaust pipe sections together. Place a new gasket around upper pipe and against outside of coaming. Install the gasket retainer and fasten securely to coaming with sheet metal screws. Install engine compartment front lid screen (par. 58). Lower engine compartment lid.

c. Install Muffler. Place muffler front clamp over rear end of upper exhaust pipe and rear clamp over muffler outlet pipe. Insert muffler front pipe into rear end of upper exhaust pipe. Fasten muffler clamps to deck with cap screws and tighten the front and rear clamps securely. Place muffler guard in position and fasten securely with bolts and nuts.

Section V

FITS AND TOLERANCES

Paragraph

Manifold and exhaust system service data 105

105. MANIFOLD AND EXHAUST SYSTEM SERVICE DATA.

a. Manifold.

Heat control valve shaft clearance 0.005 in.

ORDNANCE MAINTENANCE — ENGINE, ENGINE ACCESSORIES,
AND CLUTCH FOR CARGO CARRIER M28 (T15)

CHAPTER 5

IGNITION AND ELECTRICAL SYSTEMS

Section I

IGNITION SYSTEM

	Paragraph
Description and data	106
Ignition timing	107
Spark plugs	108
High-tension wiring	109
Distributor and coil	110

106. DESCRIPTION AND DATA.

a. **Description.** The ignition system incorporates the distributor, ignition coil, spark plugs, and necessary high- and low-tension wires to complete the ignition circuit. When the ignition switch is turned on, and the distributor breaker points are closed, current flows through the primary winding of the ignition coil building up a strong magnetic field within. With the opening of the distributor breaker points, the circuit is broken and a high voltage is inducted into the secondary winding within the coil. This high voltage is then passed on through the distributor and to the spark plugs by the high-tension wiring. To prevent arcing across the distributor points as they open, a condenser is connected in parallel with the points. Its purpose is to provide a reservoir for the primary circuit until the points have separated far enough to prevent an arc across the points. NOTE: The distributor on the later models can be removed without removing the engine from the vehicle.

b. **Data.**

Distributor	Fully automatic
Firing order	1-5-3-6-2-4
Coil	Shunt wound
Spark plug	Champion J-9 14 mm
Spark plug gap	0.025 in.

107. IGNITION TIMING.

a. Raise engine compartment lid, connect a neon timing light in No. 1 (rear) spark plug circuit, and start engine. The "IGN" mark on engine flywheel should appear in alignment with pointer on engine front plate at each flash of timing light. If adjustment is necessary, loosen distributor clamp bolt and rotate distributor body, right or left, until flash occurs

**ORDNANCE MAINTENANCE — ENGINE, ENGINE ACCESSORIES,
AND CLUTCH FOR CARGO CARRIER M28 (T15)**

when mark appears in alinement with pointer. A mirror will facilitate observation of timing mark on flywheel. Tighten distributor clamp bolt and lower engine compartment lid.

108. SPARK PLUGS.

a. **Description.** Six spark plugs, one for each cylinder, located in cylinder head, provide the spark necessary to fire combustible air-fuel mixture within the combustion chambers.

b. **Remove Spark Plugs.** Pull wires from spark plug terminals and remove spark plugs and gaskets. Protect spark plug hole in cylinder head to prevent any object from falling into cylinders when plugs are removed.

c. **Cleaning and Inspection.** Clean spark plugs with a sandblast cleaner according to cleaner manufacturer's directions and test with a tester. Replace any plugs that are not satisfactory for further service.

d. **Install Spark Plugs.** When installing spark plugs always use new gaskets and install with seam down. Install spark plugs and tighten with a spark plug wrench until gasket is compressed. Place plug wire terminals on plugs.

109. HIGH-TENSION WIRING.

a. **Description.** The high-tension wiring is referred to as the secondary wiring or circuit and consists of spark plug wires and coil to distributor wire. These wires are heavily insulated and carry current from coil to distributor and from distributor to spark plugs. Radio interference suppressors are installed on secondary wire from distributor to coil and on each spark plug wire at spark plug terminal.

b. **Remove High-tension Wiring.** Pull spark plug wires from spark plug terminals. Remove six spark plug wires from distributor cap by pulling terminal ends out of towers. Pull wire from center tower of distributor cap and coil tower.

c. **Cleaning and Inspection.** All grease and dirt should be removed from wires with a cloth. If corrosion is present at terminal ends and clips, sand until clean. If cracks or breaks appear in insulation, replace wires and clips.

d. **Install High-tension Wiring.** Install spark plug to distributor cap wires in cap towers in following firing order, 1-5-3-6-2-4 and install clips on spark plugs. Install secondary wire from coil tower to distributor cap center tower by pressing wire terminals firmly into towers.

110. DISTRIBUTOR AND COIL.

a. **Distributor.** For distributor disassembly, cleaning, inspection, repair, and assembly instructions, refer to TM 9-1825B.

b. **Coil.** For coil cleaning and inspection instructions, refer to

TM 9-1825B.

CHAPTER 5

IGNITION AND ELECTRICAL SYSTEMS (Cont'd)

Section II

ELECTRICAL SYSTEM

STARTING AND GENERATING EQUIPMENT

	Paragraph
Description and data	111
Starter and solenoid switch	112
Generator and regulator	113

111. DESCRIPTION AND DATA.

a. **Description.** The electrical system of this vehicle is of the single-wire grounded type (fig. 69). It consists of a heavy-duty battery, generator, starter, solenoid switch, and current and voltage regulator.

b. **Data.**

Battery	Willard, 19-plate, 12-volt, 153 amp hr
Starter	Auto-Lite—Bendix drive
Solenoid switch	Auto-Lite
Generator	Auto-Lite, air-cooled, shunt-wound, 40 amp
Current and voltage regulator	Auto-Lite—automatic

112. STARTER AND SOLENOID SWITCH.

a. **Starter.** For starter disassembly, cleaning, inspection, repairs, and assembly instructions, refer to TM 9-1825B.

b. **Solenoid Switch.** For solenoid switch cleaning, inspection, test, and repair instructions, refer to TM 9-1825B.

113. GENERATOR AND REGULATOR.

a. For generator and current and voltage regulator disassembly, cleaning, inspection, repair, assembly, and test instructions, refer to TM 9-1825B.

ORDNANCE MAINTENANCE — ENGINE, ENGINE ACCESSORIES,
AND CLUTCH FOR CARGO CARRIER M28 (T15)

CHAPTER 6
COOLING SYSTEM

Section I

DESCRIPTION AND DATA

	Paragraph
Description	114
Data	115

114. DESCRIPTION.

a. The liquid-type cooling system of this vehicle consists of radiator, fan, water pump, thermostat, and engine water jacket (fig. 70). Circula-

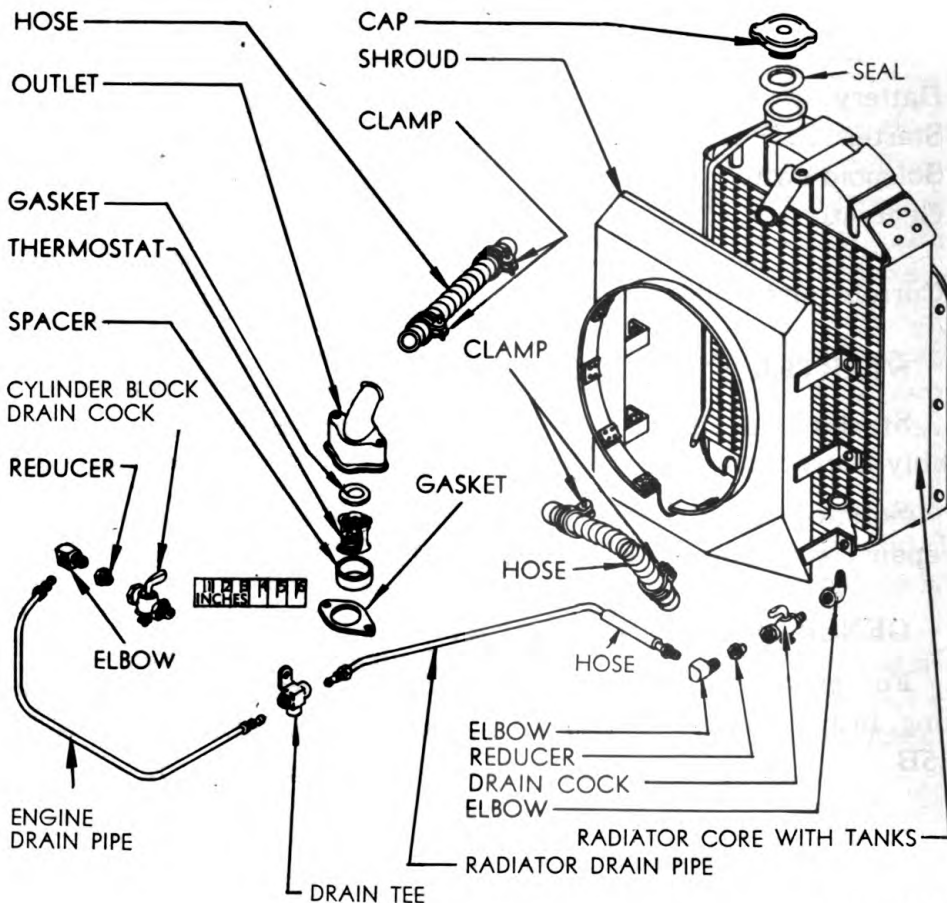

RA PD 309990

Figure 70—Radiator and Connecting Parts

DESCRIPTION AND DATA

tion of the solution is actuated by the water pump. When the engine is operated, the water pump operates also. The solution temperature is controlled by a thermostat located on the cylinder head water outlet. The thermostat is closed at temperatures below 174°F. The heated solution is circulated through a coil in the battery compartment, to heat the battery. Circulation is not set up within entire cooling system until the thermostat valve opens.

115. DATA.

System Pump circulated and thermostatically controlled
 Water pump Belt driven from crankshaft pulley
 Fan 4-blade conventional type
 Capacity 10½ qt

Section II

TROUBLE SHOOTING

Trouble shooting	Paragraph 116
----------------------------	-------------------------

116. TROUBLE SHOOTING.

a. Cooling System Leaks.

Possible Cause	Possible Remedy
Radiator leaks.	Repair or replace.
Leaks at drain cocks.	Tighten or replace.
Water pump leakage.	Repair or replace.
Cooling system gasket leakage.	Install new gaskets.
Cylinder block or head cracked.	Repair or replace.
Loose radiator upper tank baffle plate.	Repair or replace radiator.
Thermostat not operating properly.	Replace.
Engine overheating.	Determine cause and correct.

b. Engine Runs Cool.

Improper thermostatic action.	Replace thermostat.
-------------------------------	---------------------

c. Engine Overheats.

Fan belt slipping.	Tighten or replace.
Cooling solution low.	Fill to proper level.
Thermostat inoperative.	Replace.
Thermostat incorrectly installed.	Install properly.

**ORDNANCE MAINTENANCE — ENGINE, ENGINE ACCESSORIES,
AND CLUTCH FOR CARGO CARRIER M28 (T15)**

Possible Cause	Possible Remedy
Deteriorated or collapsed inlet hose.	Replace.
Pump impeller loose on shaft.	Repair or replace.
Fan blades improperly installed.	Install properly.
Air intake or outlet restricted.	Open.
Cargo or duffle restricting air intake.	Remove cargo.
 d. Noisy Fan.	
Loose fan blades.	Tighten.
Bent or distorted fan blades.	Repair or replace.
 e. Noisy Fan Belt.	
Belt too tight.	Adjust.
Belt too loose.	Adjust.
Grease, rust, or foreign matter on belt or pulley.	Clean or replace.
Belt worn or frayed.	Replace.
Fan pulley misaligned.	Align.
 f. Noisy Water Pump.	
Pulley flange hub loose on pump shaft.	Replace parts as required.
Impeller loose on shaft.	Replace.
Impeller blades rubbing pump housing.	Repair or replace.
Impeller pin sheared or broken.	Replace.

CHAPTER 6
COOLING SYSTEM (Cont'd)

Section III

RADIATOR

	Paragraph
Description	117
Removal	118
Cleaning	119
Test and inspection.....	120
Installation	121

117. DESCRIPTION.

a. The radiator is the conventional tubular type. Cooling fins are used to assist in dissipating heat from the solution as it circulates through the radiator tubes to maintain normal solution temperature. The radiator is provided with a self-sealing cap.

118. REMOVAL.

a. **Drain Radiator.** Raise engine compartment lid to fully opened position. Remove hull drain plate screws, plate, and gasket from bottom of hull near rear. Remove radiator cap to unseal cooling system, and open drain valve at radiator outlet pipe, on lower left corner of radiator, to drain out solution. Close drain valve, install a new drain plate gasket after applying joint and thread compound to plate and screws, and tighten securely. Loosen hose clamp screws and remove hose from radiator and battery heater coil.

b. **Remove Radiator and Fan Shroud.** Remove fan and pulley (par. 123). Take out metal screws from each side that hold radiator flanges to hull, and lift radiator and shroud out of engine compartment (fig. 71).

119. CLEANING.

a. With radiator out of vehicle, thoroughly clean it, by reverse flushing with cleaning solution, until all evidence of rust and other foreign material is removed. To clean outside of radiator use power washing equipment to remove any material lodged between tubes and cooling fins.

120. TEST AND INSPECTION.

a. Pressure test radiator to locate leaks, and repair or replace. If repaired test radiator again to determine if satisfactory for further service.

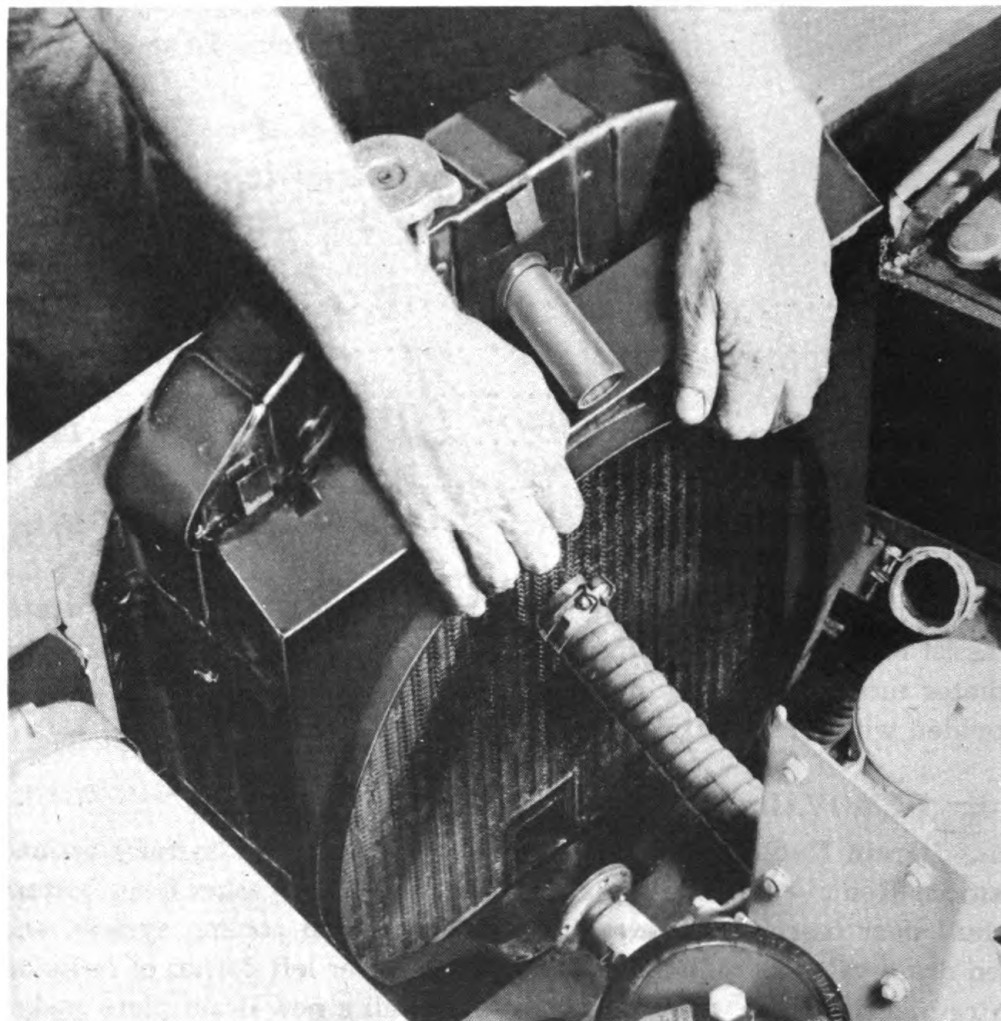
**ORDNANCE MAINTENANCE — ENGINE, ENGINE ACCESSORIES,
AND CLUTCH FOR CARGO CARRIER M28 (T15)**

RA PD 49306

Figure 71—Removing Radiator**121. INSTALLATION.**

a. Place radiator and fan shroud in position, and aline holes in hull with those in radiator flange. Install metal screws and tighten securely. Use liquid soap when installing hose to radiator and engine. Place hose clamps with bolt and nut on hose before installing to radiator and heater coil. Tighten hose clamp screws securely. Close drain valve at lower left corner of radiator. When filling the cooling system, it will be found that as much as a gallon of solution can be added after the engine has been operated long enough to open thermostat and bleed off air trapped in cooling system. Install fan pulley and blades (par. 126).

CHAPTER 6
COOLING SYSTEM (Cont'd)

Section IV

FAN, PULLEY AND BELT

	Paragraph
Description	122
Removal	123
Cleaning	124
Inspection	125
Installation	126

122. DESCRIPTION.

a. A four-blade fan positioned to push air rearward out of the engine compartment, and fan pulley are fastened to a flange on the water pump shaft and is driven by a V-type belt. The fan belt tension is adjusted by moving the generator toward, or away from, the engine.

123. REMOVAL.

a. Raise engine compartment lid. Loosen generator hinge bolts and adjusting arm pivot screw. Move generator toward engine to relieve tension on fan belt. Take out cap screws holding fan blades and pulley to water pump shaft flange, and remove fan blades and pulley. Disengage fan belt from generator and crankshaft pulleys and lift belt out of engine compartment.

124. CLEANING.

a. Wash fan blades and pulley with dry-cleaning solvent and dry with clean cloth or compressed air.

125. INSPECTION.

a. Inspect fan blades for proper pitch, cracks at mounting holes, or other damage. Inspect fan pulley for distortion, cracks, or other damage. Examine fan belt for broken cords or oil-soaked condition. Replace parts not satisfactory for further service.

126. INSTALLATION.

a. Place fan pulley and blades (positioned to blow air out rear) against water pump shaft flange, install cap screws, and tighten securely. Install fan belt on pulley and adjust tension so there is $\frac{3}{4}$ -inch deflection

**ORDNANCE MAINTENANCE — ENGINE, ENGINE ACCESSORIES,
AND CLUTCH FOR CARGO CARRIER M28 (T15)**



RA PD 49408

Figure 72—Adjusting Fan Belt

FAN, PULLEY AND BELT

of belt (fig. 72) midway between generator and fan pulleys. Tighten generator adjusting arm pivot screw and hinge bolt nuts. Turn crankshaft several revolutions with hand crank to make sure fan blades do not strike shroud. Close the engine compartment lid.

Section V

WATER PUMP

	Paragraph
Description	127
Removal	128
Disassembly	129
Cleaning	130
Inspection	131
Assembly	132
Installation	133

127. DESCRIPTION.

a. The water pump used on this vehicle is of the ball-bearing, pre-lubricated shaft type with a nonadjustable packing (fig. 73).

128. REMOVAL.

a. Drain radiator (par. 118). Remove fan blades and pulley (par. 123). Loosen hose clamp screws and remove hose from water pump. Take out cap screws and stud holding water pump to cylinder block and remove water pump, with gasket, from block (fig. 74).

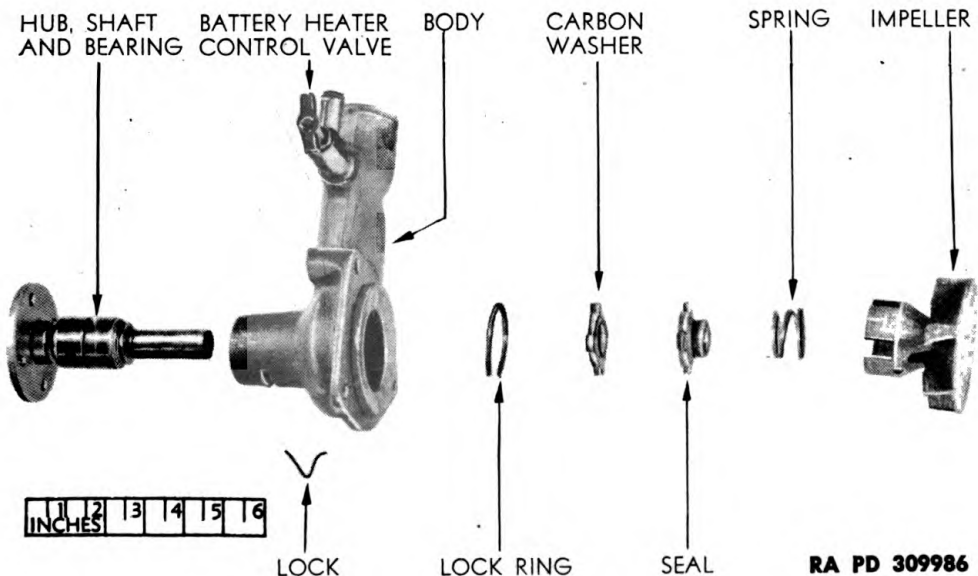

**ORDNANCE MAINTENANCE — ENGINE, ENGINE ACCESSORIES,
AND CLUTCH FOR CARGO CARRIER M28 (T15)**

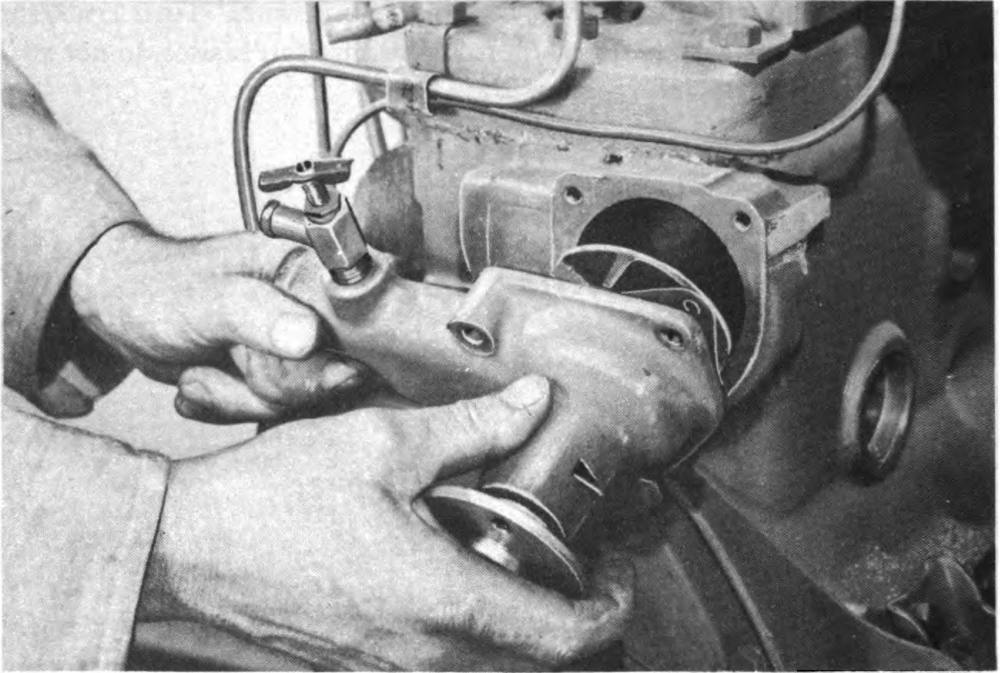

RA PD 309994

Figure 74—Removing Water Pump

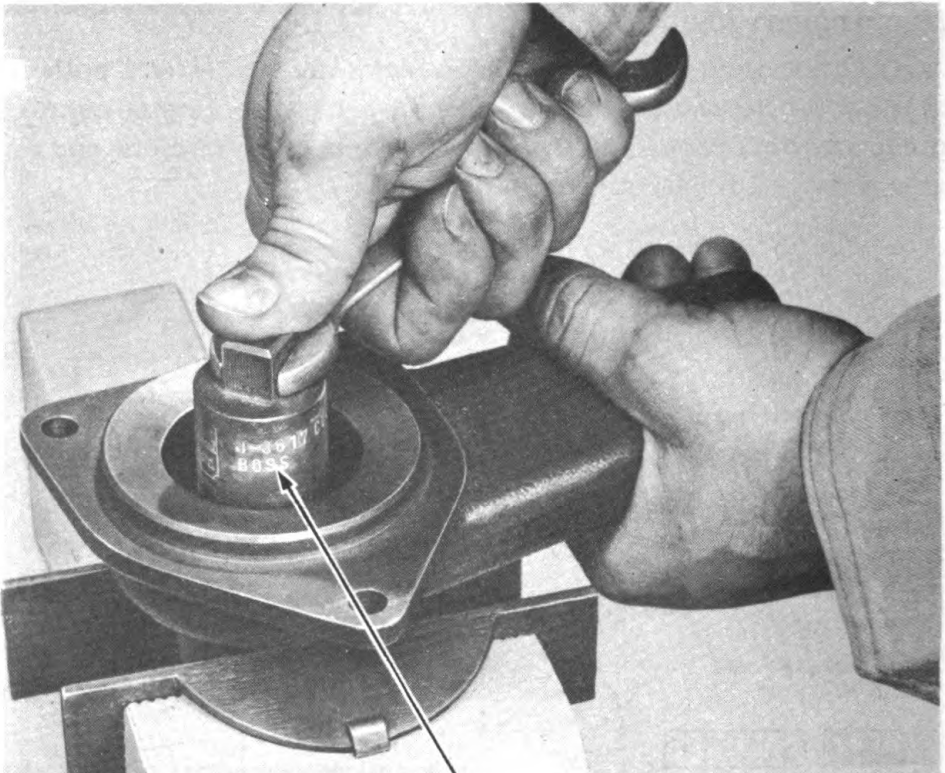

WATER PUMP FACING CUTTER 41-R-233-10

RA PD 67166

WATER PUMP

129. DISASSEMBLY.

a. Press pump shaft out of pulley flange and hub, and remove bearing lock ring from pump body. Press pump shaft with bearing out of impeller and pump body.

130. CLEANING.

a. Clean pump body thoroughly with dry-cleaning solvent and dry with compressed air. Clean pump shaft, using a cloth dampened with dry-cleaning solvent, and dry with a clean cloth.

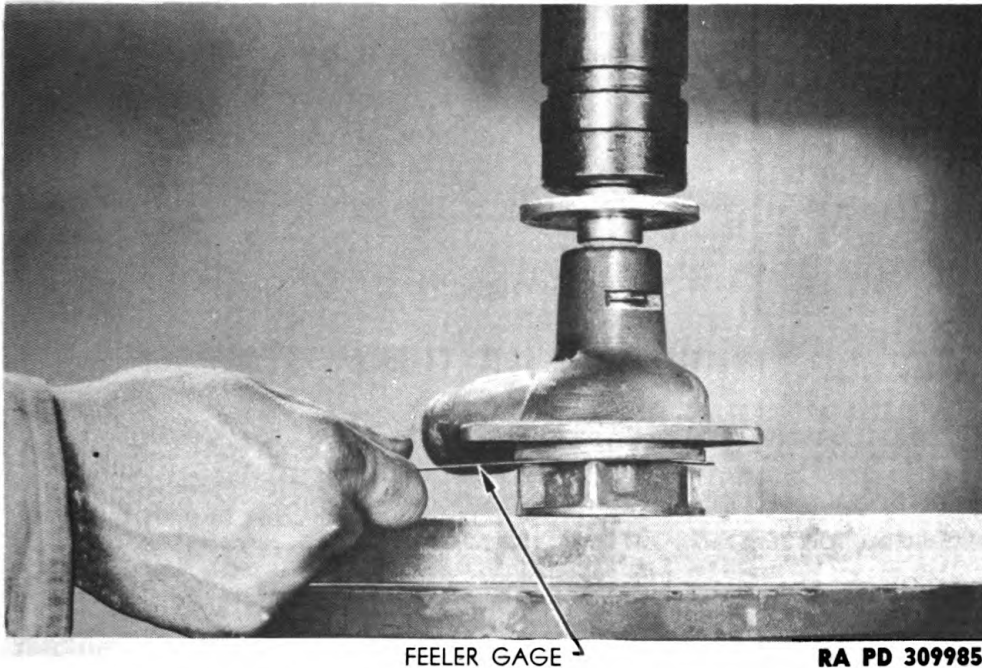

Figure 76—Assembling Impeller to Water Pump Shaft

131. INSPECTION.

a. Inspect pump body for cracks, sand holes, or damage, and replace if not satisfactory for further service. If thrust seal surface in pump body is rough or pitted, reface it with water pump facing cutter (41-R-2330-10) (fig. 75). If prelubricated bearing is dry or shaft is scored, replace parts. Examine seals for roughness or other damage and replace if not fit for further service. Inspect impeller for cracks or damage and replace if required. Examine seal spring for pits or distortion and replace if not satisfactory for further service.

132. ASSEMBLY.

a. Press pulley flange and hub on pump shaft until outer end of hub is flush with end of shaft. Install shaft with bearing and pulley hub in pump body and insert lock ring. Install spring, seals, and retaining ring in impeller. Press impeller on shaft until there is $\frac{1}{32}$ -inch clearance between

**ORDNANCE MAINTENANCE — ENGINE, ENGINE ACCESSORIES,
AND CLUTCH FOR CARGO CARRIER M28 (T15)**

impeller vanes and body (fig. 76). Test assembly before installing to cylinder block to make sure there is no scraping noise, and that shaft rotates freely.

133. INSTALLATION.

a. Install a new gasket on cylinder block; place pump in position on block; install lock washers, cap screws, and stud, and tighten securely. Lubricate inside of hose with liquid soap, install hose, and tighten clamp screws securely. Install fan pulley and fan blades (par. 126). Close drain valve at lower left corner of radiator. When filling cooling system it will be found that all the solution cannot be installed at once. Start engine, allow it to operate long enough to open thermostat and bleed off the air trapped in cooling system, then fill radiator to proper level. Close engine compartment lid.

Section VI

ENGINE WATER THERMOSTAT

	Paragraph
Description	134
Removal	135
Inspection and test	136
Installation	137

134. DESCRIPTION.

a. The thermostat used in this vehicle is of the bellows type, and is mounted in the cylinder head water outlet. It is set to start opening at approximately 174°F and is fully open at 177°F. By constantly opening and closing, it holds the solution in the engine at the most efficient operating temperature.

135. REMOVAL.

a. Drain the radiator (par. 118). Loosen hose clamp screws, remove outlet to radiator hose, and remove cylinder head cap screws holding water outlet to cylinder head. Remove water outlet, gasket, thermostat sleeve, and thermostat (fig. 77).

136. INSPECTION AND TEST.

a. If thermostat is known to be faulty, replace it. The best known method of testing thermostat is to immerse it in water heated to a temperature of 174°F. If valve does not start to open, or if it sticks in fully open position, replace it.

ENGINE WATER THERMOSTAT

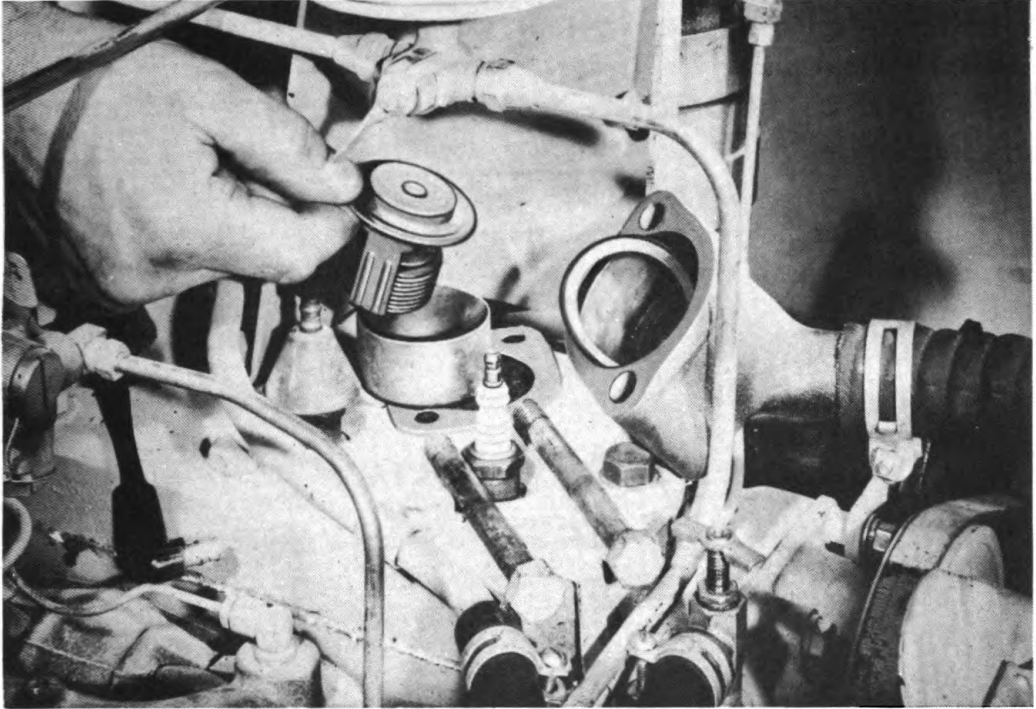

RA PD 49400

Figure 77—Removing Engine Thermostat

137. INSTALLATION.

a. When installing thermostat, make sure that the bellows are downward, and small bypass hole in valve is open. If not installed in this manner, the thermostat will be entirely useless, resulting in overheating of solution and engine. Install new gaskets to flange and sleeve bore. Place water outlet in position, insert cap screws, and tighten to between 600 to 650 inch-pounds with a tension wrench. Place hose on water outlet and radiator connection, and tighten clamp screws. Fill cooling system to the proper level. Close engine compartment lid.

ORDNANCE MAINTENANCE — ENGINE, ENGINE ACCESSORIES,
AND CLUTCH FOR CARGO CARRIER M28 (T15)

CHAPTER 6

COOLING SYSTEM (Cont'd)

Section VII

FITS AND TOLERANCES

Cooling system service data	Paragraph 138
---------------------------------------	------------------

138. COOLING SYSTEM SERVICE DATA.

- Impeller to pump body clearance $\frac{1}{32}$ in.
- Fan belt adjustment $\frac{3}{4}$ -in. belt deflection
- Thermostat starts opening 174°F
- Thermostat fully open 177°F

ANTIFREEZE SOLUTION CHART

Temperature (in deg F).	+20°	+10°	0°	-10°	-20°	-30°	-40°	-50°
Antifreeze compound								
—U.S. qt. . .	2	2	3.5	4	4.5	5	6	6.5

CHAPTER 7

CLUTCH

Section I

DESCRIPTION AND DATA

	Paragraph
Description	139
Data	140

139. DESCRIPTION.

a. The clutch is a single-plate, dry-disk type. A driven member, with suitable facings, contacts the flywheel face and clutch pressure plate. The clutch cover assembly consists of a pressure plate, six pressure springs, release levers, and cover, which is enclosed in the clutch housing bolted to the engine front plate (fig. 78).

140. DATA.

Make	Borg and Beck
Type	Single-plate—dry-disk
Vibration damper	Yes
Number driving members	2
Number driven members	1
Number facings	2
Number of pressure springs	6
Release bearing	Prelubricated

ORDNANCE MAINTENANCE — ENGINE, ENGINE ACCESSORIES,
AND CLUTCH FOR CARGO CARRIER M28 (T15)

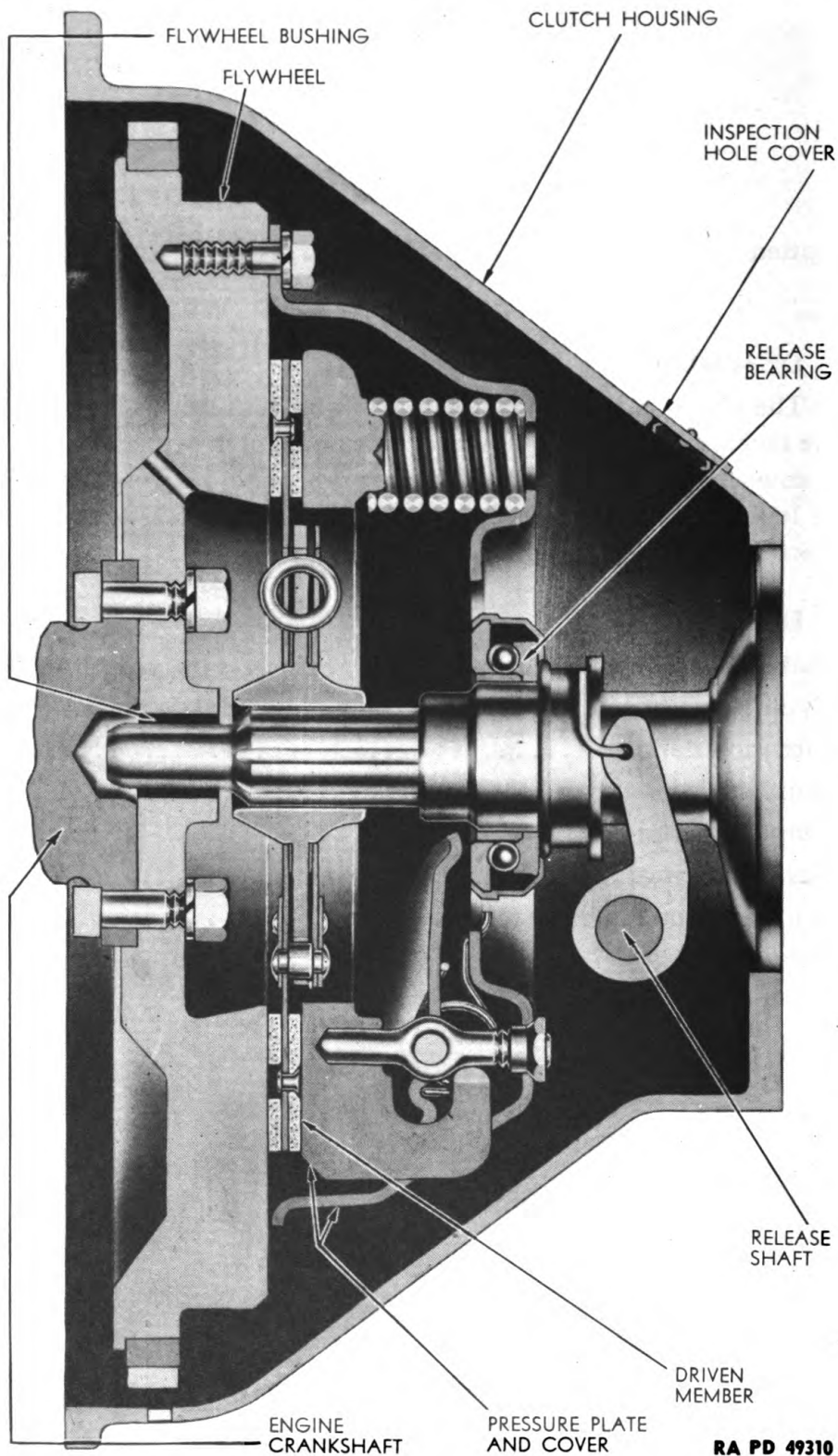

Figure 78—Clutch Assembly Cross Section

CHAPTER 7
CLUTCH (Cont'd)

Section II

TROUBLE SHOOTING

Trouble shooting	Paragraph 141
------------------------	--------------------------------

141. TROUBLE SHOOTING.

a. Slipping.

Possible Cause	Possible Remedy
Insufficient clutch pedal clearance.	Adjust clutch pedal clearance.
Weak pressure plate spring action.	Replace springs.
Torn clutch facings.	Replace facings.
Grease on clutch facings.	Replace facings.
Worn facings.	Replace facings.
Clutch parts binding.	Clean and lubricate.

b. Chatter.

Weak springs.	Replace springs.
Oil on facings.	Replace facings.

c. Dragging.

Insufficient clutch pedal travel.	Adjust clutch pedal travel.
Driven splines sticking on plate.	Clean splines.

d. Noise.

Release bearing noisy.	Replace bearing.
Release bearing worn.	Replace bearing.
Splines of driven plate worn.	Replace driven plate.

**ORDNANCE MAINTENANCE — ENGINE, ENGINE ACCESSORIES,
AND CLUTCH FOR CARGO CARRIER M28 (T15)**

CHAPTER 7

CLUTCH (Cont'd)

Section III

CLUTCH HOUSING

	Paragraph
Description	142
Removal	143
Disassembly	144
Inspection	145
Assembly	146
Installation	147

142. DESCRIPTION.

a. **Description.** The clutch housing is a bell-shaped casting with machined surfaces at engine and transmission mountings. It is fastened to the engine rear plate and encloses the clutch pressure plate, driven plate, flywheel, clutch release shaft, and release bearing.

143. REMOVAL.

a. **Support Engine Weight at Rear.** Remove vehicle top and bows (par. 7). Remove engine compartment front lid screen, front lid, and engine compartment lid (par. 7). Drain radiator (par. 7). Remove cylinder head cap screw (between two rear spark plugs) and install engine lifting eyebolt (41-B-1586-10). Attach a lifting chain and hoist to support the weight of the flywheel end of engine.

b. **Remove Transmission.** Remove seats from cockpit (par. 7). Disconnect remote control shift rods from transmission shift levers. Remove nuts, lock washers, and U-bolts from front universal joint. Move joint out of axle unit driving flange, pull propeller shaft forward, and remove from vehicle. Take out cap screws holding engine transmission support front mounting to hull cross member. Remove cap screws and lock washers holding transmission to clutch housing and remove from vehicle.

c. **Remove Clutch Housing.** Remove battery compartment cover and disconnect battery (par. 7). Remove bulkhead with units attached (par. 7). Disconnect clutch pedal pull back spring. Remove cotter pin and clevis pin from clevis at clutch operating shaft lever. Remove bolts holding starter motor to engine rear plate. Disconnect cable from terminal on

CLUTCH HOUSING

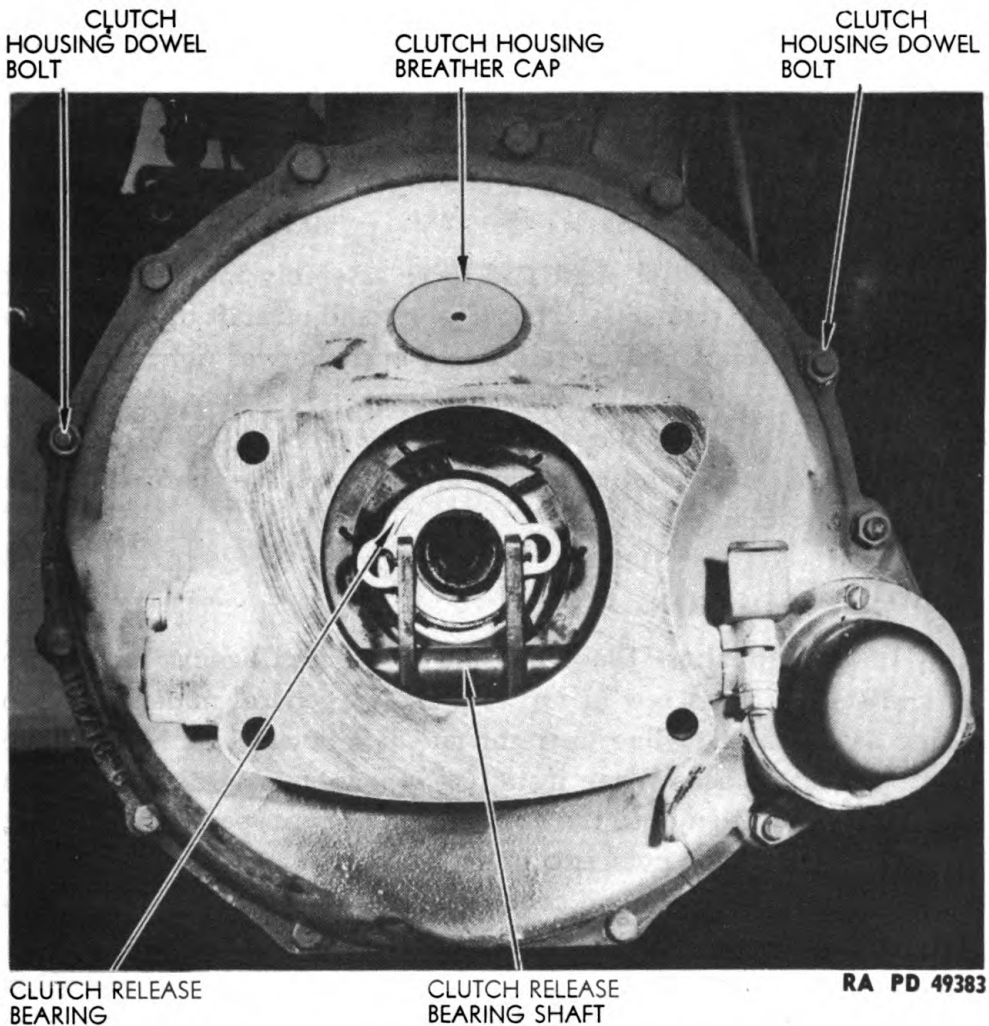

Figure 79—Clutch Release Mechanism

starter motor and move motor away from engine rear plate. Remove housing dowel bolts and nuts and tap dowels out of engine rear plate. Remove balance of screws and bolts and remove housing from vehicle.

144. DISASSEMBLY.

a. Remove bearing from clutch release shaft assembly by disengaging spring which holds bearing to shaft inner levers. Remove external lever from left end of release shaft by loosening clamp bolt and nut, and pull lever off shaft. Remove Woodruff key from keyway in shaft. Take out cap screw that holds bushing and retainer assembly to housing and remove from housing and end of shaft. Remove shaft assembly through engine side of housing.

145. INSPECTION.

a. Clean housing thoroughly with dry-cleaning solvent. Examine housing carefully for cracks and machined surfaces for burs or other dam-

**ORDNANCE MAINTENANCE — ENGINE, ENGINE ACCESSORIES,
AND CLUTCH FOR CARGO CARRIER M28 (T15)**

age. Inspect release shaft for scores or loose inner levers. Examine release bearing for roughness or damage. Inspect bushings for scores or looseness. Replace any parts not fit for further service.

146. ASSEMBLY.

a. Insert right end of shaft and lever assembly into clutch housing and through hole in right side. Then slip left end of shaft through bushing in left side of housing, place retainer and bushing over right end of shaft and fasten in position on housing with cap screw. Hook ends of spring which hold bearing and collar in position on levers. Place Woodruff key in keyway on shaft, install operating lever on release shaft, and tighten clamp bolt and nut (fig. 79).

147. INSTALLATION.

a. **Install Housing.** Place housing in position against engine front rear and start a cap screw at top to preserve general alinement. Move housing as required to line up right and left dowel bolt holes and tap dowel bolts into place. When installing a new housing do not place the dowel bolts in position until the housing has been properly alined. Install all bolts, lock washers, nuts, except starter fastening bolts and nuts, and tighten moderately. Install all cap screws and tighten moderately. Insert universal expanding pilot-type, clutch plate alining tool (41-T-3085) through clutch housing bore until pin enters pilot bushing in flywheel, and move housing as required until alining plate enters transmission pinion flange bore in clutch housing. Tighten cap screws and bolt nuts alternately, and progressively, to preserve alinement. Fasten starter securely to engine rear plate with bolts and nuts. Connect cable to terminal on starter motor. Install bulkhead with units attached (par. 58). Connect battery and install battery compartment cover (par. 58).

b. **Install Transmission and Connect Clutch Operating Cable.** Place transmission in position against clutch housing, install cap screws, and tighten securely to housing. Install cap screws through engine transmission support mounting and tighten securely to hull cross member. Connect remote control shift rods to transmission shift levers and adjust length if necessary. Install propeller shaft slip joint on transmission mainshaft and connect front universal joint to axle unit driving flange using universal joint clamp assembly. Hook clutch pull back spring to operating lever, and connect cable clevis to operating lever with clevis pin and new cotter pin. Adjust cable if required (par. 165). Install seats in cockpit (par. 58).

CLUTCH HOUSING

c. **Release Engine Weight at Transmission Support.** Release engine weight and remove hoist and lifting chain. Take out engine lifting eyebolt, install cylinder head cap screw, and tighten to a tension of 600 to 650 inch-pounds. Install engine compartment lid, front lid, and front lid screen (par. 58). Install vehicle top and bows (par. 58). Fill cooling system to proper level.

Section IV

CLUTCH COVER WITH PRESSURE PLATE

	Paragraph
Description and data	148
Removal	149
Disassembly	150
Cleaning	151
Inspection	152
Assembly	153
Installation	154

148. DESCRIPTION AND DATA.

a. **Description.** The clutch pressure plate assembly consists of a cover with release levers, pressure springs, and pressure plate proper.

b. **Data.**

Make Borg and Beck
Number of pressure springs 6

149. REMOVAL.

a. Remove clutch housing (par. 143). Loosen progressively, each of pressure plate cover to flywheel cap screws, by turning only one-half turn at a time to prevent clutch springs from distorting cover flange. After loosening cap screws until all pressure has been relieved, remove cap screws and pressure plate assembly.

150. DISASSEMBLY.

a. To disassemble the clutch pressure plate, use a hacksaw to break away seal of release lever adjusting nuts. Place pressure plate assembly on bed of an arbor press with a hardwood block across top of cover, resting on spring bosses. Compress assembly with arbor press (fig. 80) and back off adjusting nuts. Release arbor press pressure, slowly, to prevent springs from flying out, and lift off cover (fig. 81). Remove springs and disas-

**ORDNANCE MAINTENANCE — ENGINE, ENGINE ACCESSORIES,
AND CLUTCH FOR CARGO CARRIER M28 (T15)**

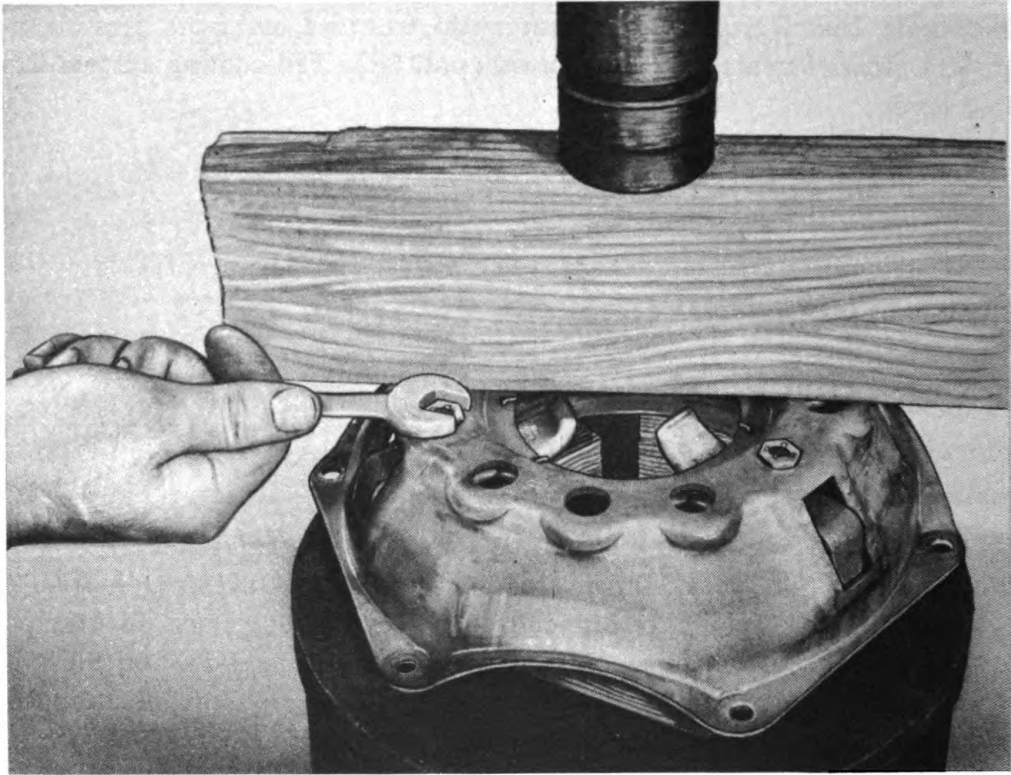

RA PD 67004

Figure 80—Compressing Cover Springs

semble release levers by grasping eyebolt between thumb and fingers so that inner end of lever and upper end of eyebolt are as near together as possible, keeping eyebolt seated in lever socket (fig. 82). Lift strut over ridge on end of lever and lift lever and eyebolt off pressure plate.

151. CLEANING.

a. Wash all parts with dry-cleaning solvent. Any grease should be scraped or brushed off and parts washed again with dry-cleaning solvent. Dry with clean cloth or compressed air.

152. INSPECTION.

a. Inspect for: cracks, or distortion of cover; cracks, breaks, scores, or distortion of pressure plate; and damaged release fingers, eyebolts, and struts. Compress pressure springs with a suitable tester to a length of $1\frac{1}{2}$ inches. Satisfactory springs will require from 135 to 145 pounds pressure to compress. Replace any parts not satisfactory for further service.

CLUTCH COVER WITH PRESSURE PLATE

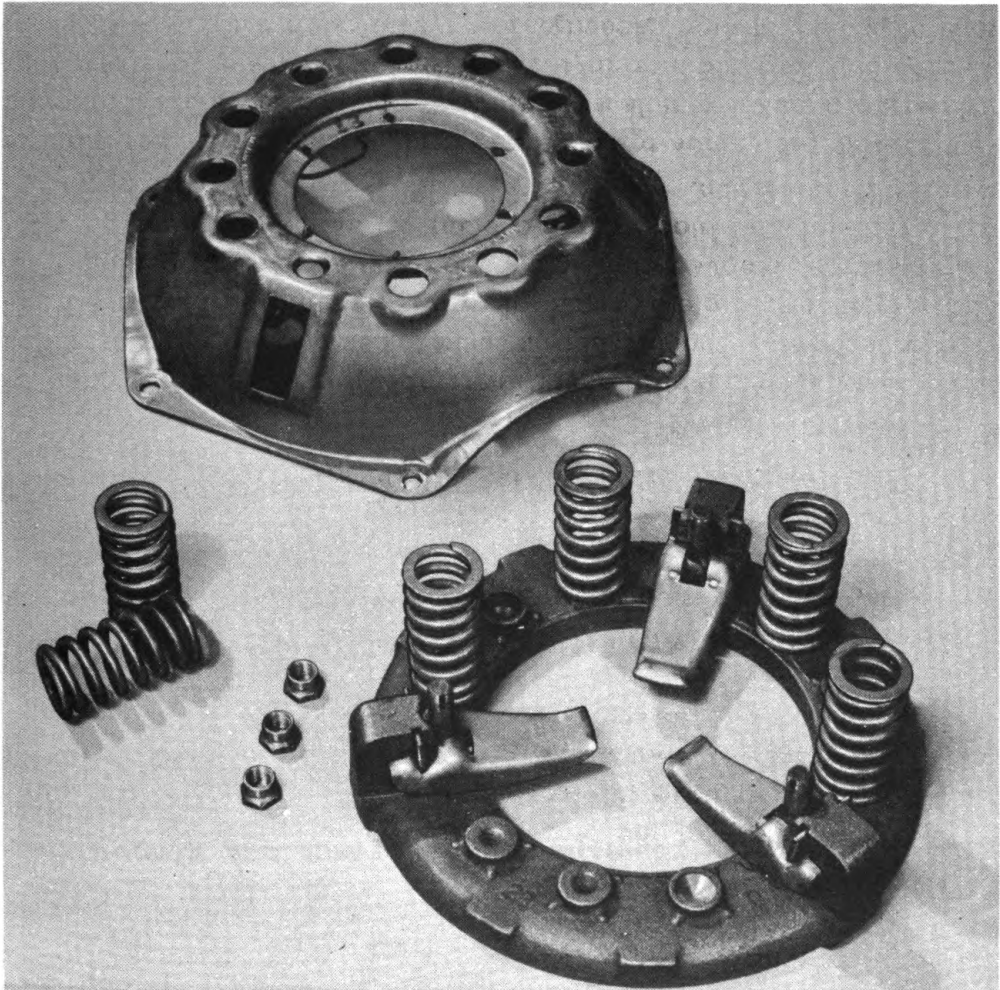

RA PD 67007

Figure 81—Cover Removed from Pressure Plate Assembly

153. ASSEMBLY.

a. Insert lower end of eyebolt into hole in pressure plate and lubricate lug (fig. 83). Assemble release lever and eyebolt, holding lever and eyebolt as close together as possible (fig. 84). Insert strut in slots of pressure plate lug, drop slightly, and tilt lower edge until it touches the vertical milled surface of lug. Slide strut upward in slots of lug, lift over ridge on short end of lever, and drop into groove in lever.

b. Assemble pressure springs (fig. 85) on pressure plate (fig. 86). Place cover on top of pressure plate springs. Mount driven plate and pressure plate assembly on holding fixture, and slowly compress cover, making sure eyebolts and pressure plate lugs are guided through holes in cover. Hold clutch under compression and tighten adjusting nuts until flush with top of eyebolts. Depress levers several times with a hammer handle to settle parts into position.

**ORDNANCE MAINTENANCE — ENGINE, ENGINE ACCESSORIES,
AND CLUTCH FOR CARGO CARRIER M28 (T15)**

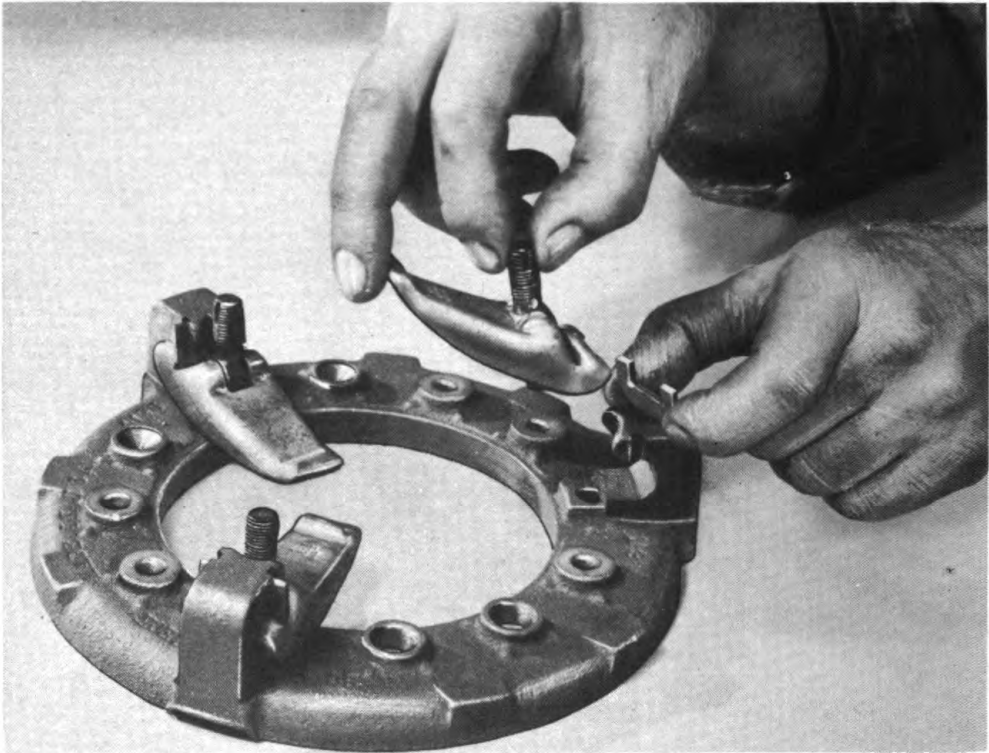

RA PD 67005

Figure 82—Removing Release Lever and Eyebolt

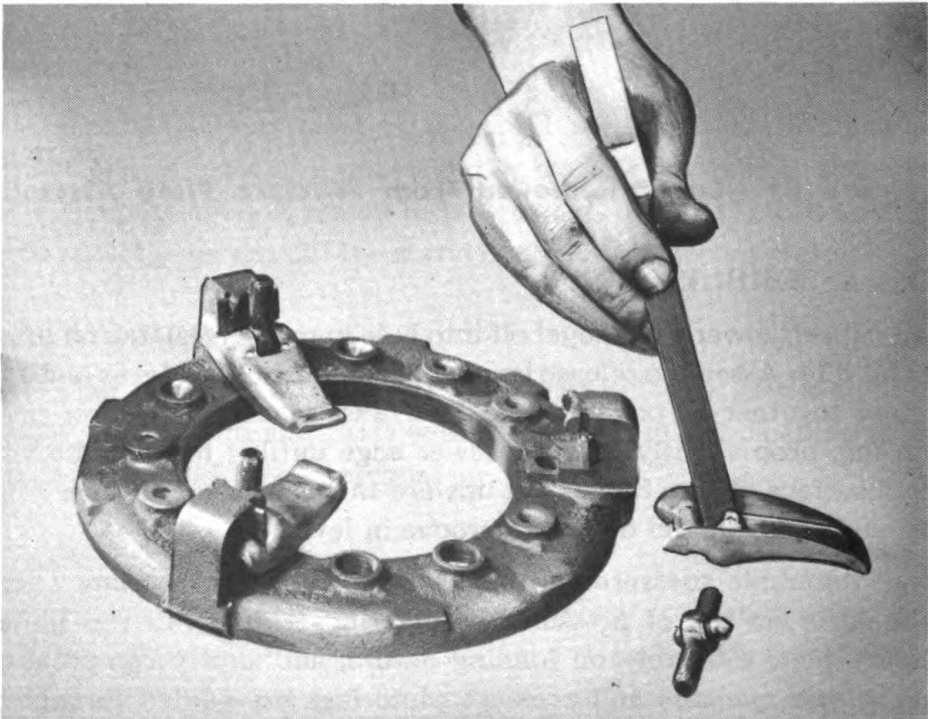

RA PD 67006

Figure 83—Lubricating Pressure Plate Lugs

CLUTCH COVER WITH PRESSURE PLATE



RA PD 66965

Figure 84—Removing or Installing Release Lever in Eyebolt

c. Adjust levers until bearing contact surfaces are $1\frac{1}{8}$ inch down from outer surface of cover. This measurement is taken by placing a straightedge across spring bosses on cover, and measuring to lever from lower surface of straightedge to determine height of lever. Set clutch finger setting gage to first lever height and adjust other levers to same height. After adjusting lever height, stake nuts with a dull punch by driving nut metal into grooves in eyebolt to provide a secure lock (fig. 87). Remove assembly from fixture.

154. INSTALLATION.

a. Coat clutch pilot bushing in flywheel with suitable lubricant and place driven plate against machined surface of flywheel with longest extension of hub away from flywheel face. Insert clutch alining arbor (41-T-3085) through hub of driven plate and into clutch pilot bushing. Place pressure plate assembly (fig. 88) in position against driven plate, install cap screws through cover flange, and tighten them, evenly and progressively, about one-half turn at a time, to avoid distorting cover. Give screws a final tightening to make sure assembly is securely fastened to flywheel and remove alining arbor. Install clutch housing (par. 147).

**ORDNANCE MAINTENANCE — ENGINE, ENGINE ACCESSORIES,
AND CLUTCH FOR CARGO CARRIER M28 (T15)**

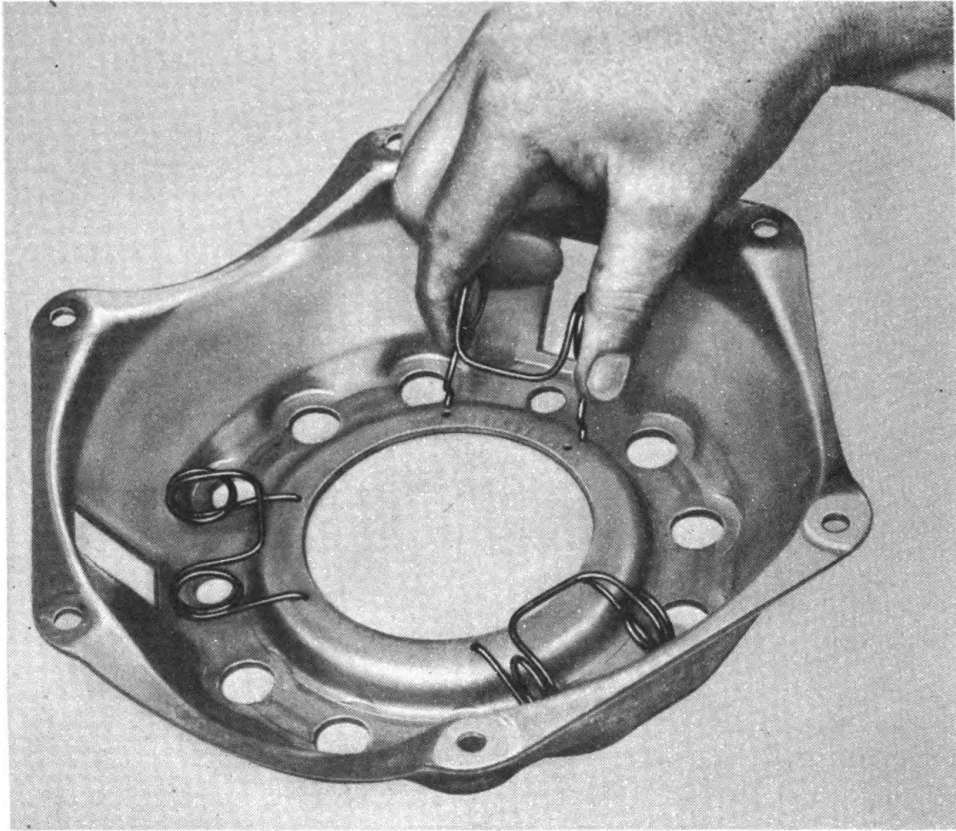

RA PD 67009

Figure 85—Installing Release Lever Return Springs in Cover

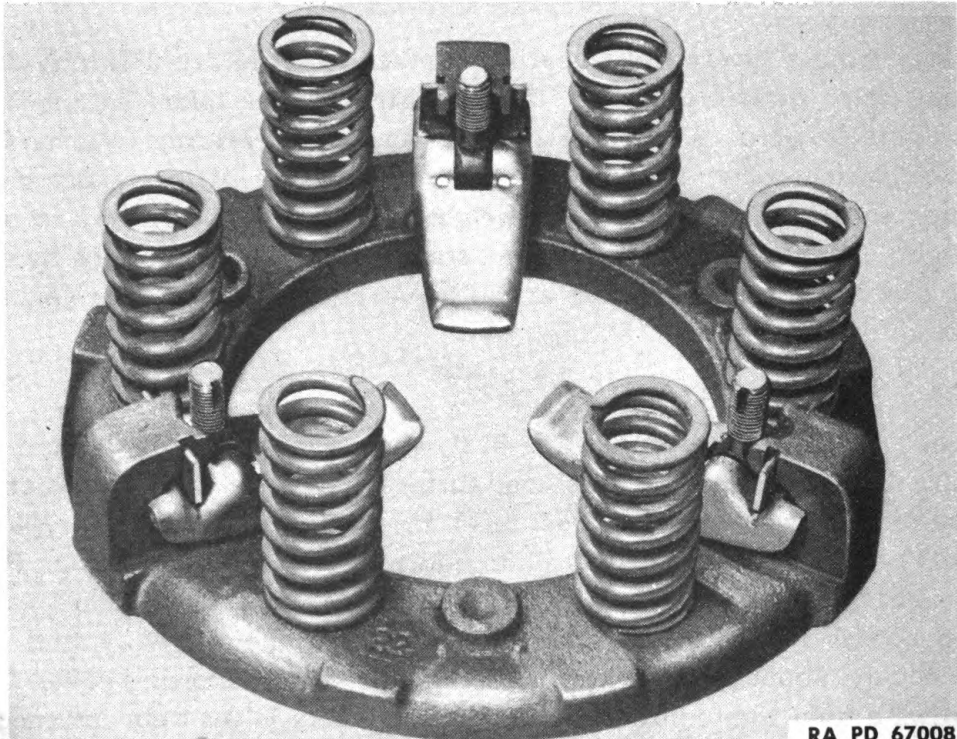

RA PD 67008

CLUTCH COVER WITH PRESSURE PLATE



RA PD 66956

Figure 87—Locking Release Lever Adjusting Nut

**ORDNANCE MAINTENANCE — ENGINE, ENGINE ACCESSORIES,
AND CLUTCH FOR CARGO CARRIER M28 (T15)**

CLUTCH ALINEMENT ARBOR (PIN) 41-T-3085

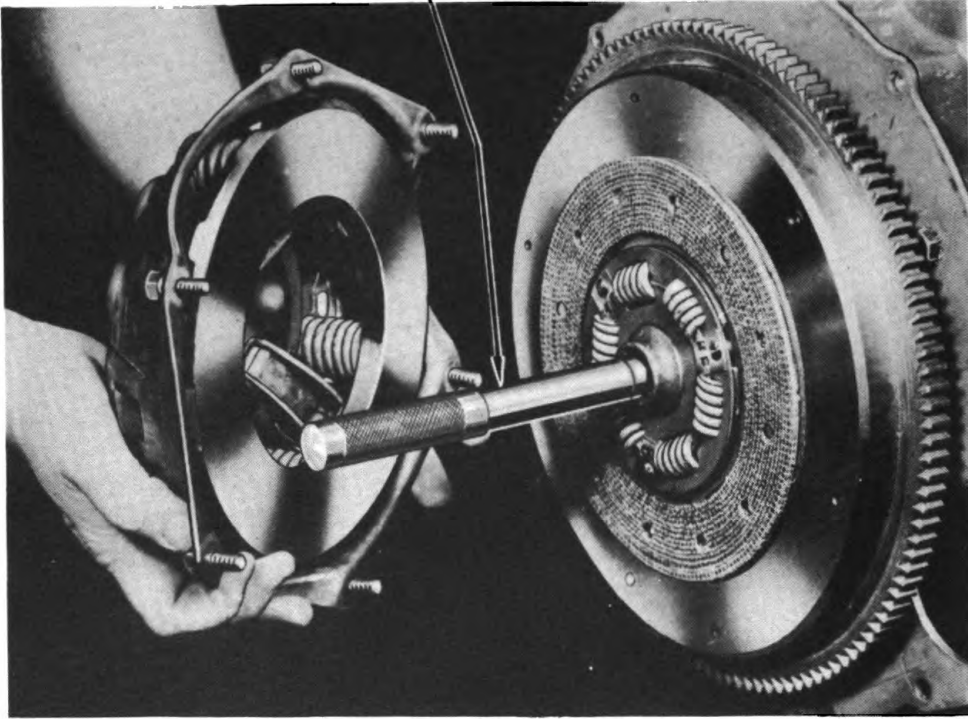

RA PD 66937

Figure 88—Installing Clutch Pressure Plate Assembly

Section V

CLUTCH DRIVEN PLATE WITH FACINGS

	Paragraph
Description and data.....	155.
Removal	156
Disassembly	157
Cleaning	158
Inspection	159
Assembly	160
Installation	161

155. DESCRIPTION AND DATA.

a. Description. The clutch driven plate consists of a spring-loaded disk mounted on a splined hub and faced on both sides with special facing material riveted into position.

CLUTCH DRIVEN PLATE WITH FACINGS

b. Data.

Make.....Borg and Beck
TypeSingle-plate—dry-disk
Vibration damperYes
Number of facings..... 2

156. REMOVAL.

a. Remove clutch cover with pressure plate (par. 149). Remove clutch driven plate with facings.

157. DISASSEMBLY.

a. Other than to replace friction facings, no disassembly of clutch driven plate should be attempted. To remove old facings, rivets must be drilled out with a $\frac{3}{16}$ -inch drill. Do not punch them out, as in doing so, driven plate may be damaged or distorted.

158. CLEANING.

a. Wash driven plate with dry-cleaning solvent. Dry with clean wiping cloth or compressed air.

159. INSPECTION.

a. Inspect driven plate for distorted or warped condition, loose rivets at plate hub, and damaged splines in hub. Other than replacing facings, no reconditioning of driven plate is to be attempted. Replace the plate if not satisfactory for further service.

160. ASSEMBLY.

a. Place facing on flywheel side of driven plate so that countersunk holes are alined with rivet holes in cushion spring and resting on cushion spring which is convex at this point. Insert rivet head in counterbore of facing, and roll rivet (do not split) against cushion spring. Rivet each cushion spring to this facing before installing other facing. Turn driven plate over and aline countersunk holes of pressure plate facing with holes in cushion spring. Insert rivet head in counterbore of facing and roll rivet (do not split) against cushion spring. The rivet holes for this facing are nearest edge of cushion spring. Each rivet goes through one facing only.

161. INSTALLATION.

a. Install clutch driven plate and cover assembly (par. 154)

ORDNANCE MAINTENANCE — ENGINE, ENGINE ACCESSORIES,
AND CLUTCH FOR CARGO CARRIER M28 (T15)

CHAPTER 7
CLUTCH (Cont'd)

Section VI

CLUTCH CONTROL AND LINKAGE

	Paragraph
Description	162
Removal	163
Inspection	164
Installation	165

162. DESCRIPTION.

a. The clutch is controlled by a foot pedal and arm located in the extreme forward end of driver's compartment on the left side. The pedal arm is connected to a flexible cable running through cockpit to clutch release shaft lever at clutch housing.

163. REMOVAL.

a. Remove seats from cockpit (par. 7). Take out cotter pins and clevis pins holding cable clevises to pedal arm and clutch release shaft

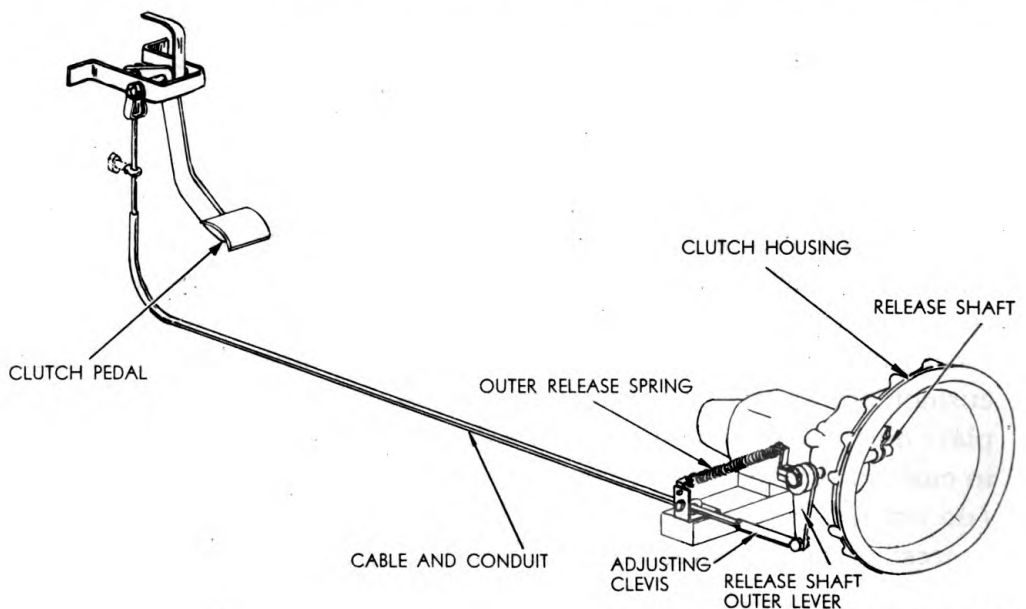

RA PD 49298

Figure 89—Clutch Release Linkage

CLUTCH CONTROL AND LINKAGE

operating lever. Remove J-bolts holding cable conduit to bracket at transmission and forward wall of hull. Lift cable and conduit out of vehicle. Remove cotter pin, castle nut, and bolt, holding clutch pedal to bracket on front wall of hull.

164. INSPECTION.

a. Inspect cable for broken wires and loose connections at clevises. If damaged, replace entire assembly. Inspect clevis pins for damage, and replace as necessary. Inspect clevises for cracks, distortion, or other damage, and replace parts as required. Examine pedal for distortion or other damage, and replace if not fit for further service.

165. INSTALLATION.

a. Place pedal and arm in bracket on forward wall of hull. Install bolt, nut, and new cotter pin. Place cable and conduit in position along left side of cockpit with front end under axle unit housing. Connect cable front clevis to pedal arm with clevis pin and new cotter pin. Fasten cable conduit to forward wall of hull and bracket at transmission with J-bolts. Connect cable adjustable clevis to clutch release shaft operating lever with clevis pin.

b. Loosen pedal (fig. 89) stop screw lock nut and turn stop screw in until it bottoms on lock nut. Remove clevis pin from adjustable clevis, loosen clevis lock nut, and turn clevis to shorten, or lengthen, cable until no slack, or pull, exists on release shaft operating lever, when clevis holes are alined with hole in lever. Install clevis pin and new cotter pin. Back off pedal stop screw until one inch of free pedal travel is present before clutch disengagement starts. Lock stop screw with lock nut. Install seats in cockpit (par. 58).

ORDNANCE MAINTENANCE — ENGINE, ENGINE ACCESSORIES,
AND CLUTCH FOR CARGO CARRIER M28 (T15)

CHAPTER 7

CLUTCH (Cont'd)

Section VII

FITS AND TOLERANCES

	Paragraph
Clutch service data	166

166. CLUTCH SERVICE DATA.

Facing—inside diameter	5 ³ / ₈ in.
Facing—outside diameter	8 in.
Facing—thickness	1/8 in.
Facing—required	2
Free pedal travel	1 in.
Spring pressure on plate	1,300 lb
Spring pressure	135 to 145 lb at 1 1/2 in.

CHAPTER 8
SPECIAL TOOLS

Section I

SPECIAL TOOLS

Special tools.....	Paragraph 167
--------------------	------------------

167. SPECIAL TOOLS.

Nomenclature	Federal Stock Number	Mfr's. Number
Anvil, rivet assembly, drive track.....	41-A-281-50	J-3648
Eyebolt, engine lifting.....	41-B-1586-150	J-3614
Guide, bogie wheel, rerailer.....	41-G-1236	J-3633
Protector, synchronizer, transmission...	41-P-2839-725	J-3643
Puller, bearing and retainer, rear trans- mission mainshaft.....	41-P-2900-20	J-3640
Pusher set, crankshaft and camshaft gear, crankshaft pulley.....	41-P-4710	J-3644
Refacer, bearing, needle, track support..	41-R-2391-29	J-3613
Replacer, piston pin.....	41-R-2395-100	J-3619
Replacer, axle differential, final drive gear bushing.....	41-R-2390-930	J-3639
Replacer, inner oil seal, bogie wheel....	41-R-2394-257	J-3646
Replacer, inner and outer bearing cup, drive wheel.....	41-R-2394-255	J-3608
Replacer, water pump housing seat.....	41-R-2330-10	C-551
Set, rivet, drive track.....	41-S-2198	J-3647
Wrench, socket, single head.....	41-W-2940-55	J-3603

**ORDNANCE MAINTENANCE — ENGINE, ENGINE ACCESSORIES,
AND CLUTCH FOR CARGO CARRIER M28 (T15)**

REFERENCES

STANDARD NOMENCLATURE LISTS.

- Carrier, cargo M28 (T15) (Studebaker) SNL G-154
 - Cleaning, preserving and lubrication materials, recoil fluids, special oils, and miscellaneous related items . . SNL K-1
 - Soldering, brazing, and welding materials, gases, and related items SNL K-2
 - Tools, maintenance for repair of automotive vehicles . . . SNL G-27
 - Tool sets—motor transport SNL N-19
 - Tool sets, for ordnance service command, automotive shops SNL N-30
- Current Standard Nomenclature Lists are listed above.
An up-to-date list of SNL's is maintained as the "Ordnance Publications for Supply Index" OPSI

EXPLANATORY PUBLICATIONS.

- Military motor vehicles AR 850-15
- List of publications for training FM 21-6

Related Technical Manuals.

- Light Cargo Carrier (T15) TM 9-893
- Ordnance maintenance: Power train, suspension system, hull, and hull electrical system for Cargo Carrier M28 (T15) TM 9-1893B
- Ordnance maintenance: Electrical equipment (Auto-Lite) TM 9-1825B

Automotive Materiel.

- Automotive electricity TM 10-580
- Carburetors (Carter) TM 9-1826A
- Electric fundamentals TM 1-455
- Electrical equipment (Auto-Lite) TM 9-1825B
- Fuels and carburetion TM 10-550
- The internal combustion engine TM 10-570
- The motor vehicle TM 10-510
- Tune-up and adjustments TM 10-530

Care and Preservation.

- Automotive lubrication TM 10-540

REFERENCES

- Cleaning, preserving, lubricating, and welding materials and similar items issued by the Ordnance Department TM 9-850
 - Explosives and demolitions FM 5-25
 - Motor transport inspections TM 10-545
 - Product guide OFSB 6-2
- Decontamination.**
- Chemical decontamination materials and equipment . TM 3-220
 - Decontamination of Armored Force vehicles FM 17-59
 - Defense against chemical attack FM 21-40
- Storage and Shipment.**
- Registration of motor vehicles AR 850-10
 - Rules governing the loading of mechanized and motorized army equipment, also major caliber guns, for the United States Army and Navy, on open top equipment published by Operations and Maintenance Department of Association of American Railroads.
 - Storage of motor vehicle equipment AR 850-18
 - Ordnance field service storage and shipment chart—group G major items OSSC-G

**ORDNANCE MAINTENANCE — ENGINE, ENGINE ACCESSORIES,
AND CLUTCH FOR CARGO CARRIER M28 (T15)**

INDEX

A	Page No.		Page No.
Accessories on engine, installation of		disassembly	79
carburetor	64	installation	84
clutch and housing	66	removal	75
distributor and wiring	66	Cleaning and inspection	
fuel pump	65	carburetor	79
generator	66	clutch driven plate with facings ..	137
ignition coil	66	engine	24
manifold assembly	64	engine parts	34
oil filter assembly	65	fuel pump	91, 94
spark plugs	64	fuel tank	96
starter	67	high-tension wiring	108
transmission	67	manifold	102
water pump	66	spark plugs	108
Adjustment		water pump	119
carburetor accelerator	86	Cleaning of engine parts	34
carburetor and linkage	84	Clutch	
carburetor choke	86	clutch cover with pressure plate ..	129
carburetor hand throttle	86	control and linkage	138
Assembly		data	123
camshaft gear to camshaft	58	description	123
carburetor	80	driven plate with facings	136
clutch housing	128	fits and tolerances	140
clutch driven plate with facings ..	137	housing	126
crankshaft gear to crankshaft	57	trouble shooting	
cylinder head to cylinder block	62	chatter	125
engine	54	dragging	125
engine support brackets to cylinder		noise	125
block	57	slipping	125
flywheel to crankshaft	59	Clutch control and linkage	
fuel pump	94	description	138
fuel tank	97	removal	138
manifold	102	Clutch cover with pressure plate	
oil pan to cylinder block	63	assembly	131
oil pump to cylinder block	60	cleaning	130
oil strainer assembly	63	description and data	129
water pump	119	disassembly	129
		inspection	130
		installation	133
		removal	129
B		Clutch driven plate with facings	
Battery		assembly	137
disconnect	20	cleaning	137
		description and data	136
		disassembly	137
		inspection	137
C			
Carburetor			
adjust carburetor and linkage	84		
assembly	80		
cleaning and inspection	79		
description and data	75		

**ORDNANCE MAINTENANCE — ENGINE, ENGINE ACCESSORIES,
AND CLUTCH FOR CARGO CARRIER M28 (T15)**

E—Cont'd	Page No.		Page No.
Echelon system of maintenance		oil pressure relief valve	48
allocation—Cont'd		oil pump parts	45
propeller shafts	10	oil strainer	44
suspension group	10	valve lifters	45
transmission	11	valves and valve springs	42
vehicle assembly	11	installation and test	68
Electrical system		installation of accessories	
description and data	109	carburetor	64
generator and regulator	109	clutch and housing	66
starter and solenoid switch	109	distributor and wiring	66
Engine		fuel pump	65
accessories, removal of	25	generator	66
assembly		ignition coil	66
camshaft gear to camshaft	58	manifold assembly	64
connecting rods and piston as-		oil filter assembly	65
semblies	54	spark plugs	64
crankshaft gear to crankshaft	57	starter	67
crankshaft to cylinder block	54	transmission	67
cylinder head to cylinder block	62	water pump	66
engine support brackets to cyl-		removal	19
inder block	57	removal of accessories	
flywheel to crankshaft	58	carburetor	26
front and rear plates to cylinder		clutch	25
block	54	distributor with wiring	26
oil pan to cylinder block	63	fuel pump	26
oil pressure relief valve to cyl-		generator	25
inder block	54	ignition coil	25
oil pump to cylinder block	60	manifold assembly	26
oil strainer assembly	63	oil filter assembly and diluter	26
cleaning	34	spark plugs	26
data	12	starter	25
description and operation	12	transmission	25
disassembly	27	water pump	26
fits and tolerances		repair and rebuilding	
engine service data	71	crankshaft	50
inspection	24	cylinder block	50
inspection of parts		trouble shooting	16
camshaft	45	Engine water thermostat	
connecting rods	46	description	120
crankshaft	47	inspection and test	120
crankshaft pulley and starting		installation	121
jaw	42	removal	120
cylinder block	48	Exhaust pipes and muffler	103
cylinder head	42		
engine front and rear plates	47	F	
engine support bracket mount-		Fan, pulley and belt	
ings	47	cleaning	115
flywheel	37	description	115
oil pan	44	inspection	115

INDEX

F—Cont'd	Page No.		Page No.
Fan pulley and belt—Cont'd		excessive fuel consumption....	74
installation	115	fast idling	74
removal	115	lack of fuel at carburetor.....	74
		low fuel pressure.....	74
Fits and tolerances			
clutch service data.....	140	I	
cooling system service data.....	122	Ignition system	
engine service data	71	description and data.....	106
fuel system service data.....	99	distributor and coil.....	108
manifold and exhaust system....	105	high-tension wiring.....	108
Fuel system		spark plugs.....	108
carburetor		timing	106
adjust carburetor and linkage.	84	Inspection of engine parts.....	37
assembly	80	Installation	
cleaning	79	air cleaner and engine oil.....	69
data	75	bulkhead with units.....	69
description	75	carburetor	84
disassembly	79	clutch assembly.....	66
inspection	79	clutch control and linkage.....	139
installation	84	inspection	139
removal	75	clutch driven plate with facings..	137
data	73	clutch housing.....	67, 128
description	73	clutch transmission.....	128
fits and tolerances.....	99	connecting rods and piston assem-	
fuel pump		blies	56
assembly	94	engine	68
cleaning	91	engine compartment front lid and	
data	88	hinge	69
description	88	engine compartment front lid	
disassembly	88	screen	70
inspection	94	engine compartment lid.....	70
installation	94	engine lifting eyes	23
removal	88	engine water thermostat.....	121
testing	94	exhaust pipes and muffler	
fuel tank		lower exhaust pipe and elbow..	105
assembly	97	muffler	105
cleaning	96	upper exhaust pipe.....	105
description	95	fan, pulley and belt.....	115
disassembly	95	fan pulley and blades.....	69
inspection	96	fan shroud.....	69
installation	97	fuel pump.....	94
removal	95	testing	94
primer		fuel tank.....	97
description	98	high-tension wiring.....	108
inspection	98	manifold	103
installation	99	primer	99
removal	98	inspection and test.....	98
test	98	propeller shaft.....	68
trouble shooting		radiator	69, 114
carburetor overflowing.....	74	rear air duct.....	69

**ORDNANCE MAINTENANCE — ENGINE, ENGINE ACCESSORIES,
AND CLUTCH FOR CARGO CARRIER M28 (T15)**

I—Cont'd	Page No.	References	Page No.
Installation—Cont'd			
seats	70	explanatory publications	
spark plugs	108	automotive materiel	142
timing gear cover and crankshaft pulley	61	care and preservation	142
top and bows	70	decontamination	143
valves and valve springs	59	related technical manuals	142
valve lifters and camshaft	57	storage and shipment	143
water pump	120	standard nomenclature lists	142
Installation and test of engine	68	Removal	
Introduction		camshaft	29
arrangement of manual	4	camshaft and valve lifters	29
maintenance allocation	5	carburetor	75
scope of manual	4	clutch control and linkage	138
M		clutch cover with pressure plate	129
Maintenance allocation, echelon system	6	clutch housing	126
Manifold and exhaust system		connecting rods and pistons	30
data	100	crankshaft	32
description	100	crankshaft pulley	27
exhaust pipes and muffler		cylinder head	27
description	103	demolition timer control switch	20
removal	103	engine	
manifold		air cleaner	20
assembly	102	battery compartment cover	20
cleaning	102	bulkhead	20
description	101	engine compartment front lid and hinge	20
disassembly	101	engine compartment front lid screen	19
inspection	102	engine compartment lid	19
installation	103	fan blades and pulley	21
removal	101	propeller shafts	19
trouble shooting		rear air duct	21
engine lacks power	101	seats	19
exhaust leaks	100	vehicle top and bows	19
P		engine accessories	
Primer	98	carburetor	26
R		clutch	25
Radiator		distributor with wiring	26
cleaning	113	fuel pump	26
description	113	generator	25
installation	114	ignition coil	25
removal	113	manifold assembly	26
test and inspection	113	oil filter assembly and diluter	26
		spark plugs	26
		starter	25
		transmission	25
		water pump	26
		engine front and rear plates	31
		engine support brackets	33

INDEX

R—Cont'd	Page No.		Page No.
Removal—Cont'd		cylinder block	
engine water thermostat	120	camshaft bearings	52
inspection and test	120	cylinders	50
exhaust pipes and muffler	103	valve guides	50
fan, pulley and belt	115	valve seats	50
fire extinguisher	20		
flywheel	27	S	
fuel pump	88	Special tools	141
fuel tank	95	Starting and generating equipment .	109
high-tension wiring	108		
lower exhaust pipe and elbow	104	T	
manifold	101	Trouble shooting	
oil pan and oil strainer	28	clutch	125
oil pressure relief valve	33	cooling system	111
oil pump	28	engine	16
primer	98	fuel system	74
radiator	113	manifold and exhaust system	100
radiator and fan shroud	31		
rear demolition bomb case	20	W	
spark plugs	108	Water pump	
timing gear cover	28	assembly	119
timing gears	28	cleaning	119
valve lifters	29	description	117
valves and valve springs	27	disassembly	119
voltage regulator	20	inspection	119
water outlet and thermostat	27	installation	120
Repair and rebuilding		removal	117
crankshaft	50		

[A.G. 300.7 (7 August 1943)]

BY ORDER OF THE SECRETARY OF WAR:

G. C. MARSHALL,
Chief of Staff.

OFFICIAL:

J. A. ULIO,
Major General,
The Adjutant General.

DISTRIBUTION: R9 (4); Bn9 (2); C9 (8).

(For explanation of symbols, see FM 21-6)

NOTES

NOTES

NOTES

NOTES

